

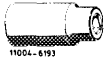

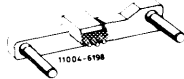
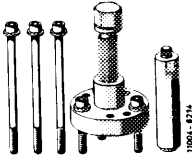

03–350 Removal and installation of crankshaft sprocket

Tightening torques

	Nm
Bolt M 18 x 1.5 x 45 on crankshaft	270–330
Nuts for cylinder head cover	15
Drain plug radiator (model 115)	6–10

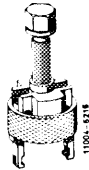
Special tools

Torque wrench 3/4" square, 150–500 Nm		001 589 31 21 00
Socket 27 mm, 1/2" square		001 589 65 09 00
Detent		110 589 00 40 00
Puller for balancing disc		116 589 10 33 00
Puller for spacing ring		616 589 00 33 00
Puller for crankshaft sprocket		615 589 01 33 00
Installer for radial sealing ring		130 589 00 61 00

Conventional tool

Adaptor 3/4" square socket to 1/2" square head	e.g. made by Hazet, D–5630 Remscheid order no. 1058 R-1
---	--

Removal

- 1 Remove radiator and fan.
- 2 Remove cylinder head cover.

For this purpose on (AUS), (J), (S) and (USA) starting 1977, push out clamp assembly of fuel hoses on holder and pull down fuel hoses with clamp assembly in forward direction over cylinder head cover.

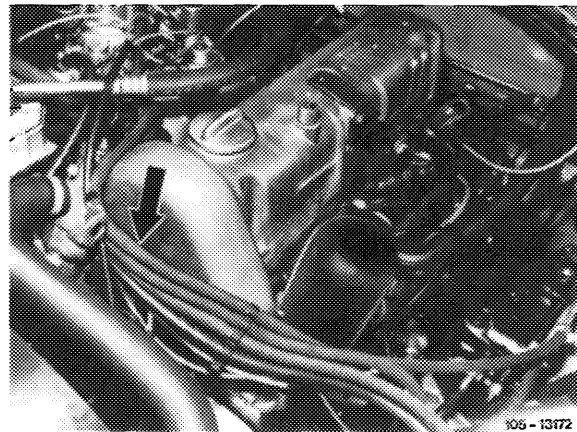
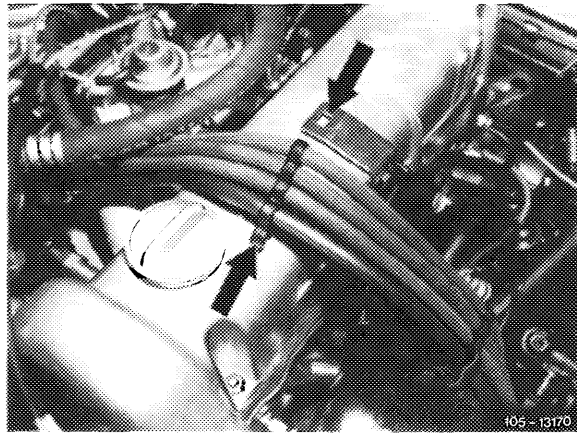

- 3 On vehicles with air conditioner, remove refrigerant compressor with carrier and connected lines and put aside.

Attention!

On engines with light alloy tensioning rail (B) the refrigerant compressor need not be removed.

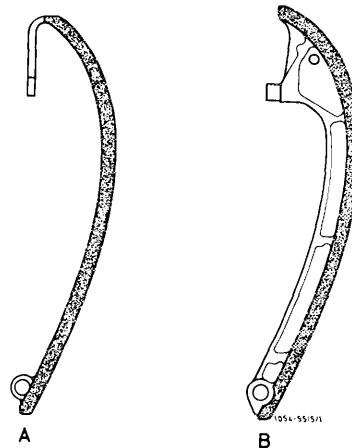

- 4 Remove pulley and balancing disc (03-340).
- 5 Remove front crankshaft radial sealing ring (03-324).

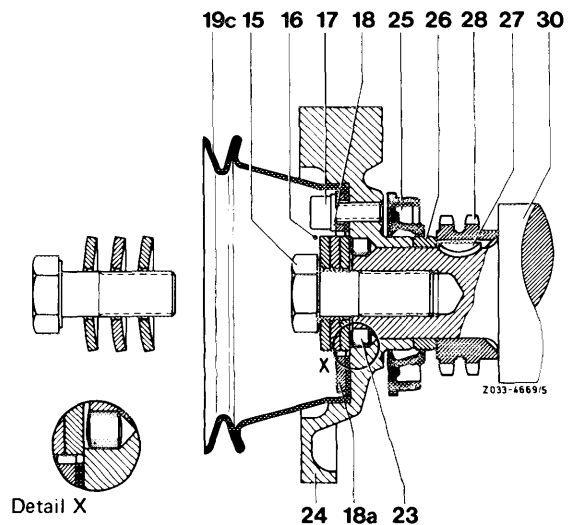

6 Pull off spacing ring (26) with puller.

7 Screw-in bolt (15) with disc springs (16).

8 On engines 115.923/926/951 with tensioning rail version (A, fig. item 3), remove chain tensioner. On engines with light alloy tensioning rail (B), push back thrust bolt of chain tensioner.

9 Unscrew spark plugs.

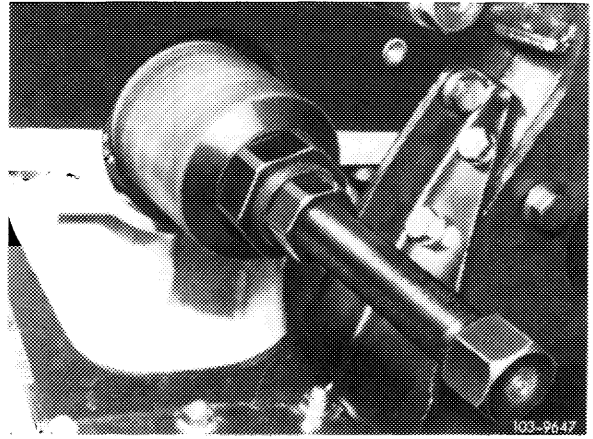

10 Cover chain box with a rag and grind off both chain bolts on one link of timing chain.

11 Insert opened chain link from front end (refrigerant pump end) and mark with paint.

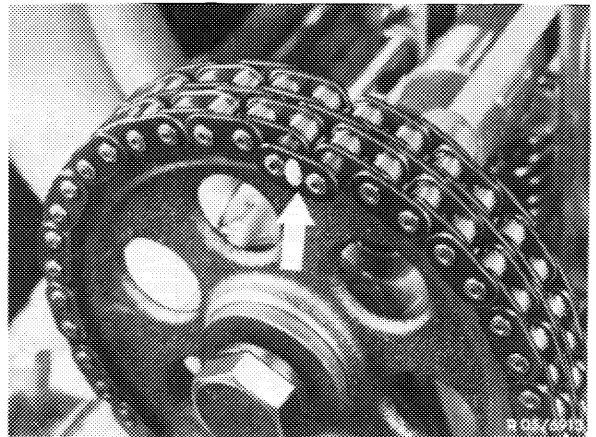

12 Rotate crankshaft with tool combination until opened chain link again shows up in mounting bore for radial sealing ring.

Attention!

Rotate crankshaft only in rotating direction of engine.

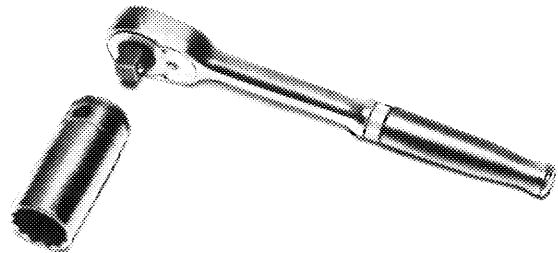

R 100/6498

13 Apply paint dot on crankshaft sprocket opposite marked chain link.

14 Pull out opened chain link and remove chain from crankshaft sprocket. For this purpose, continue rotating crankshaft slightly until the lefthand chain half (seen from the front) can be removed from crankshaft sprocket. (Chain lock on oil pan.)

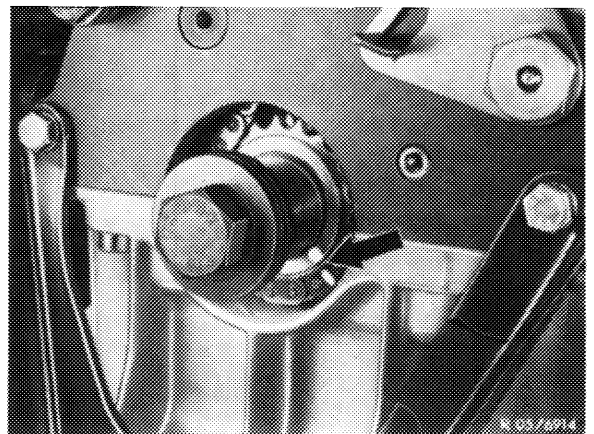

15 Pull off crankshaft sprocket by means of puller.

16 Check woodruff key in crankshaft for its condition and replace, if required.

To prevent woodruff key from falling into oil pan when it is knocked out, place a small carton or the like under crankshaft.

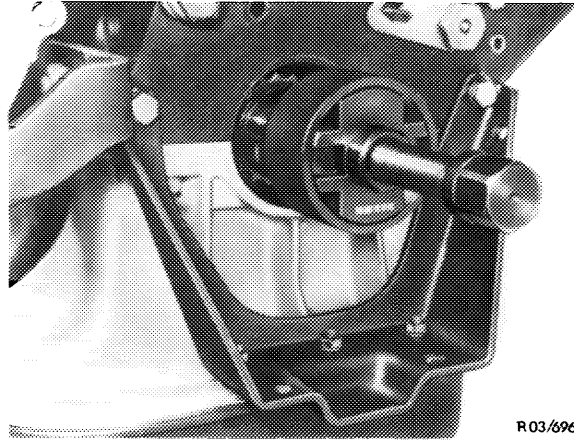

R03/6969

Installation

17 Insert new woodruff key, if required.

18 Transfer paint mark from old to new crankshaft sprocket.

19 Heat crankshaft sprocket on a hot plate (approx. 80° C) and slip on crankshaft.

20 Position righthand chain half (seen from the front) on sprocket by means of a screwdriver. Pay attention to paint mark.

21 Push chain tightly on crankshaft sprocket with screwdriver and slightly rotate crankshaft.

22 Position lefthand chain half on crankshaft sprocket.

23 Insert opened chain link. Make sure that all chain side links are connected to each other.

24 Rotate crankshaft until opened chain link rests against camshaft sprocket.

25 Remove opened chain link and insert plug link from the rear, so that the lock washers are visible from the front.

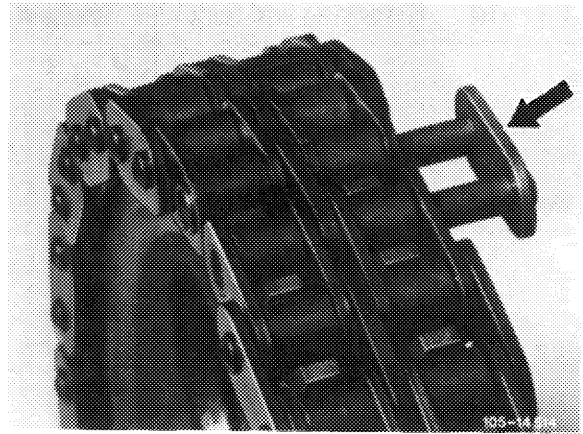

26 Push-on lock washers.

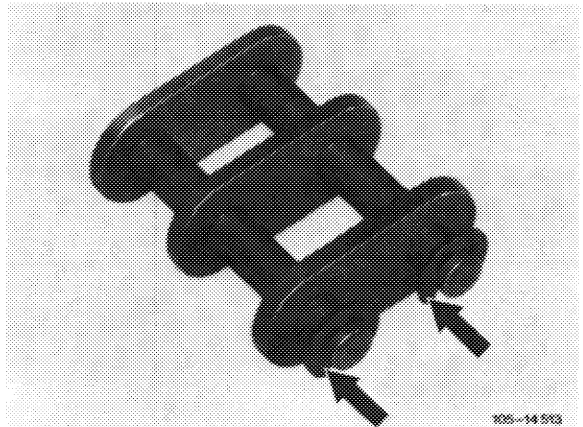

27 Continue rotating crankshaft and check adjusting marks at TDC position of engine.

28 Knock spacing ring onto crankshaft.

29 Install front crankshaft radial sealing ring (03-324).

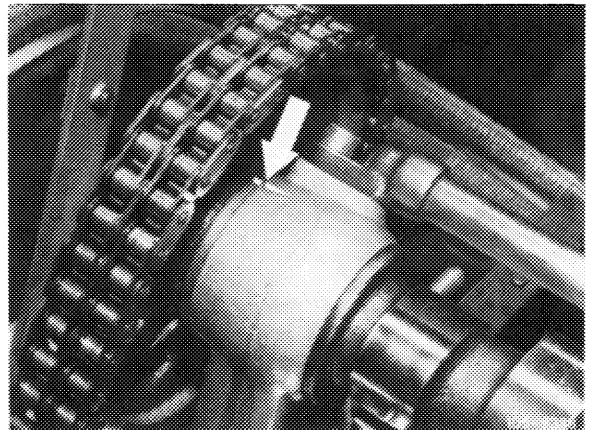

30 Install pulley and balancing disc (03-340).

31 For further installation proceed vice versa to removal.

