

A. Engine 615, 616 with M-injection pump

Length of regulating linkage

Connecting rod (from throttle unit to angle lever, Fig. item 4)	1st version	310 mm
	2nd version	317 mm
Pull rod (from guide lever to tickler shaft)	1st version	205 mm
	2nd version	225 mm

Special tool

Adjusting gauge		115 589 30 23 00
-----------------	---	------------------

Adjusting

- 1 Check regulating linkage for easy operation and distortion. Replace damaged parts, if any.
- 2 Disconnect the three regulating rods.
- 3 Check whether throttle valve closes completely without binding.
- 4 Adjust connecting rod from throttle unit to angle lever to a length of 310 mm on 1st version or 317 mm on 2nd version, measured from center to center of ball head.

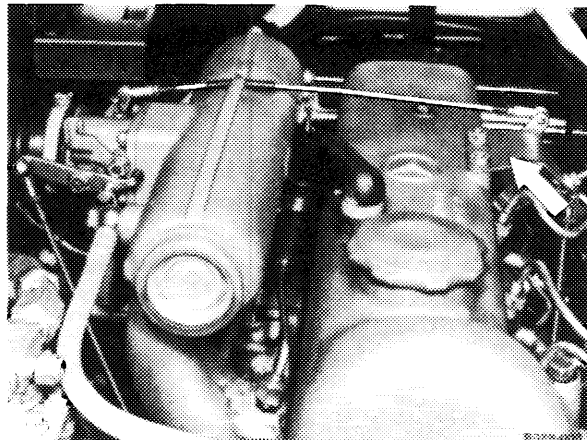

1st version flat bearing bracket

2nd version offset bearing bracket

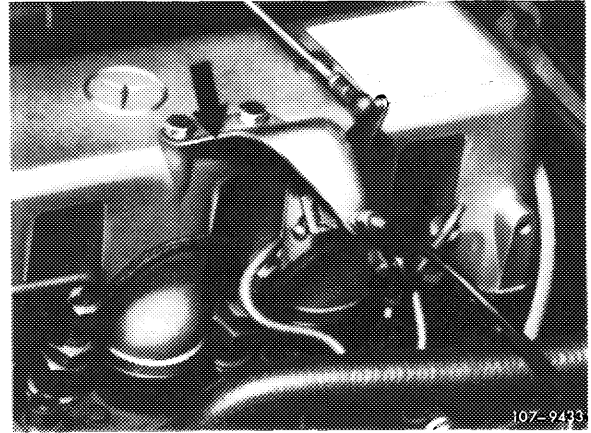

5 Vehicles with automatic transmission:

Disconnect resilient pull rod (1), control pressure rod (7) and push rod (6).

- | | |
|---|-------------------------|
| 1 Resilient pull rod
L = idle travel | 7 Control pressure rod |
| 2 Intermediate lever | 11 Adjusting gauge |
| 3 Adjustable ball head | 12 Full throttle detent |
| 6 Push rod | 13 Idle throttle detent |

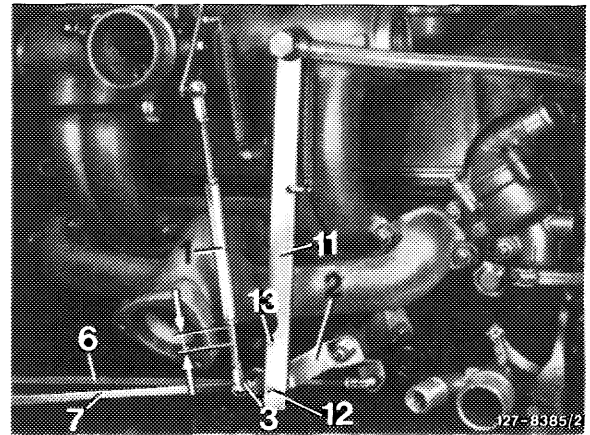

Attach adjusting gauge (11) with idle throttle detent (13) to intermediate lever (2).

Push resilient pull rod (1) completely together and attach free of tension, adjust if required. Throttle valve should rest against idle speed stop.

Push control pressure rod (7) completely to the rear to idle throttle stop and connect free of tension. Adjust with ball socket, if required.

- | | |
|----------------------|-------------------------|
| 2 Intermediate lever | 13 Idle throttle detent |
| 11 Adjusting gauge | |

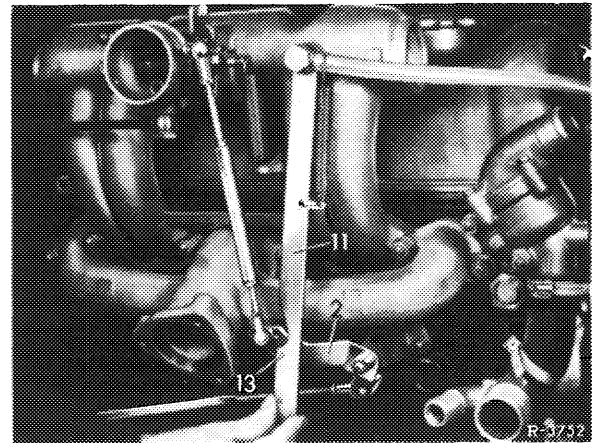

Attach push rod (6) free of tension and adjust, if required. Remove adjusting gauge (11) and accelerate to full throttle by means of accelerator pedal. Adjusting gauge (11) should permit attachment to full throttle detent (12) free of tension. Adjust front wall regulating shaft, if required (refer to item 7). Push intermediate lever (2) down, resilient pull rod (1) should then permit additionally extension for another 6 mm in relation to idle travel "L". Loosen adjustable ball head (3), if required, and adjust. Remove adjusting gauge and check kick-down position.

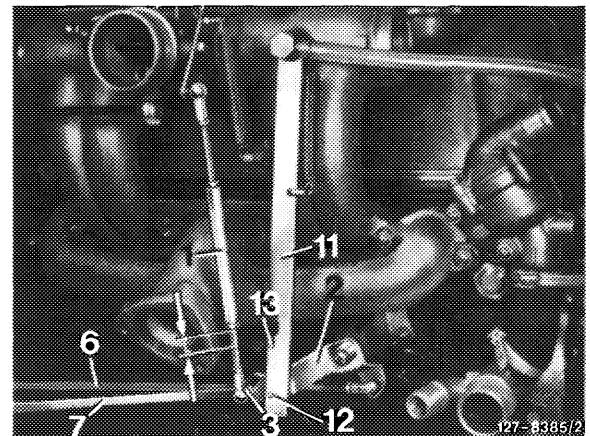

6 Adjust tickler. Disconnect connecting rod (6) from guide lever to tickler shaft on guide lever (3).

Push connecting rod (6) downwards up to stop by means of actuating lever (7).

- 3 Guide lever
- 6 Connecting rod
- 7 Actuating lever

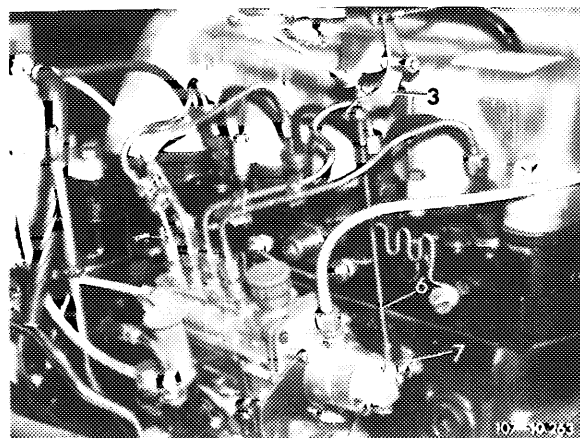

For attaching connecting rod (6), lift rod by 4 mm (half of ball head). Adjust, if required.

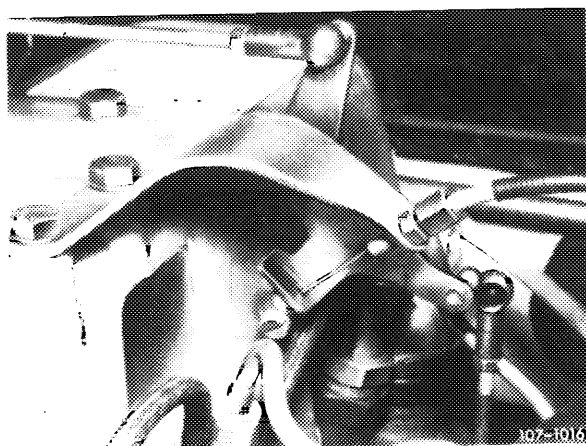

7 Check full throttle stop. With engine stopped, step down one accelerator pedal from inside vehicle up to or on vehicles with automatic transmission up to stop on kickdown switch. Accelerator pedal and the throttle valve lever should rest against full throttle stop. Adjust regulating shaft (6), if required.

For this purpose, loosen hex screw (7), pull accelerator pedal slightly outwards and tighten hex screw again. Check full throttle stop once again and repeat adjustments, if required.

Model 115.1

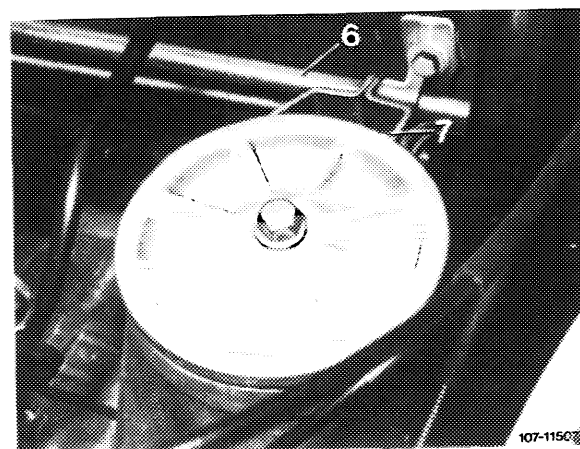
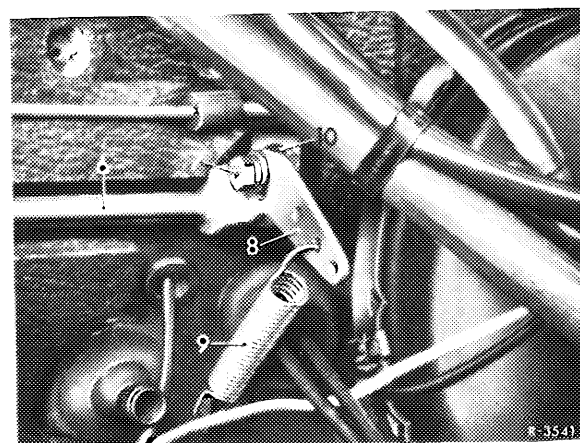

Model 123.1

Engine regulation
 Engine 615, 616 M-injection pump with pneumatic governor

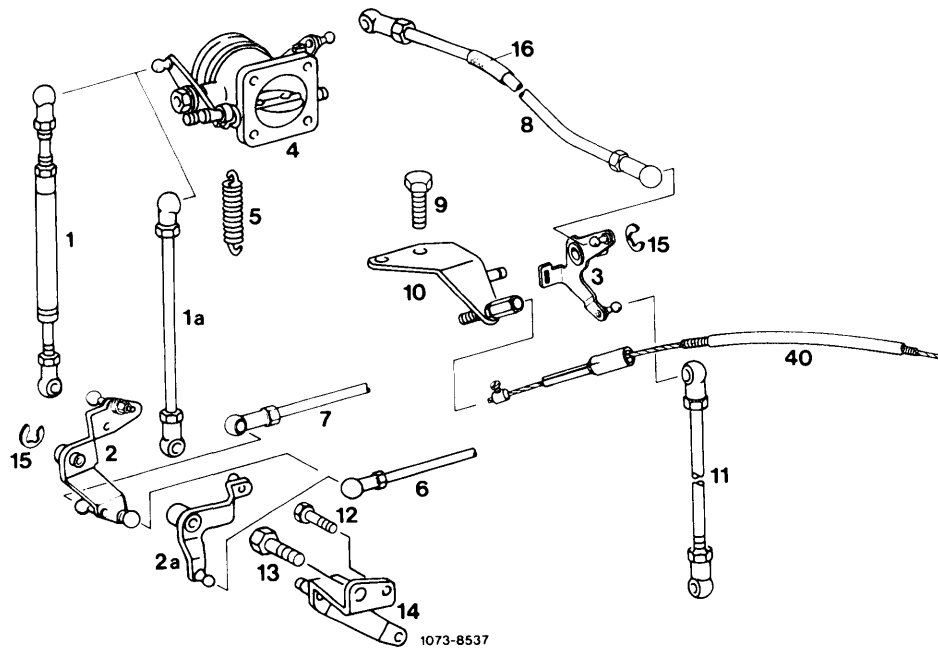

- | | | |
|---|---|---------------------------------------|
| 1 Idle path rod (automatic transmission) | 6 Connecting rod to front wall regulating shaft | 12 Hex screw |
| 1a Push rod (manual transmission) | 7 Control pressure rod | 13 Hex screw |
| 2 Intermediate lever (automatic transmission) | 8 Connecting rod | 14 Bearing |
| 2a Intermediate lever (manual transmission) | 9 Hex screw | 15 Lock |
| 3 Angle lever | 10 Holder | 16 Rubber hose |
| 4 Throttle unit | 11 Pull rod | 40 Bowden wire for idle speed ajuster |
| 5 Return spring | | |

B. Engine 617 in model 115.1 with MW-injection pump

Length of regulating linkage

Pull rod (3 in Fig. item 4)	225 mm
Connecting rod (2 in Fig. item 4) manual transmission or slide rod (2 in Fig. item 4) for automatic transmission completely extended	158 mm
Push rod (1 in Fig. item 4)	252 mm

Adjusting

- 1 Check regulating linkage for easy operation and distortion. Replace damaged parts, if any.
- 2 Disconnect all regulating rods.
- 3 Check whether regulating lever (1) of injection pump rests against idle speed stop (3).

- 1 Regulating lever 3 Idle speed stop
2 Full throttle stop

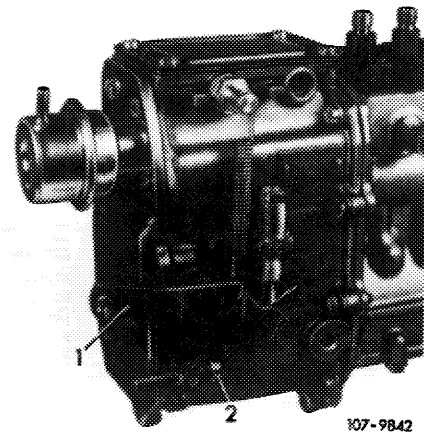

4 Vehicles with manual transmission:

- a) Adjust push rod (1) and pull rod (3) to specified length, measured from center to center of ball head and attach.

Attention!

Pull rod (3) should be covered with an **insulating hose**.

- 1 Push rod 3 Pull rod
2 Connecting rod

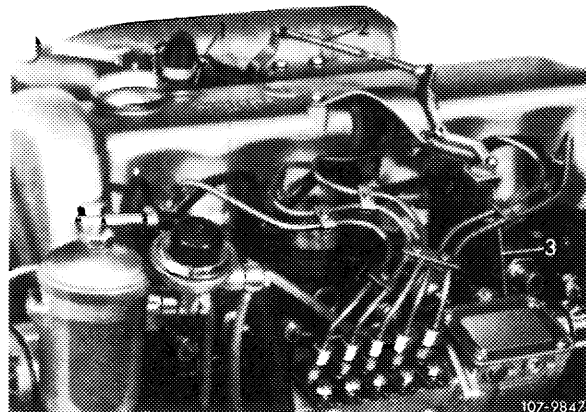

- b) Attach connecting rod (2) free of tension and adjust, if required.

c) Check full throttle stop. With engine stopped, step on accelerator pedal from inside vehicle up to stop. Accelerator pedal and regulating lever (1) should rest against full throttle stop (Fig. item 3). Adjust regulating shaft (6), if required. For this purpose, loosen hex screw (7), pull accelerator pedal slightly up and tighten hex screw again. Check full throttle stop once again and repeat adjustments, if required.

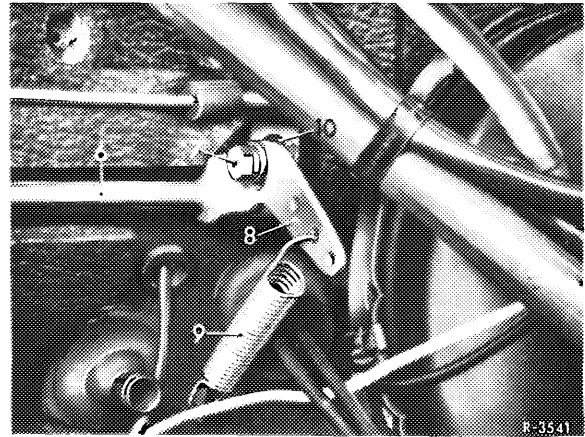

Attention!

If the regulating linkage is not moving to full throttle, check whether shaped spring for idle speed adjuster is correctly installed.

- 1 Cable control for idle speed increase
- 2 Shaped spring
- 3 Adjusting ring
- 4 Guide lever

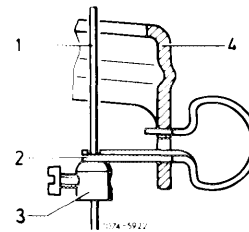

5 Check function of emergency stop button. Run engine at idle speed, push emergency stop button (arrow). Engine should stop. Adjust pull rod (2) if required.

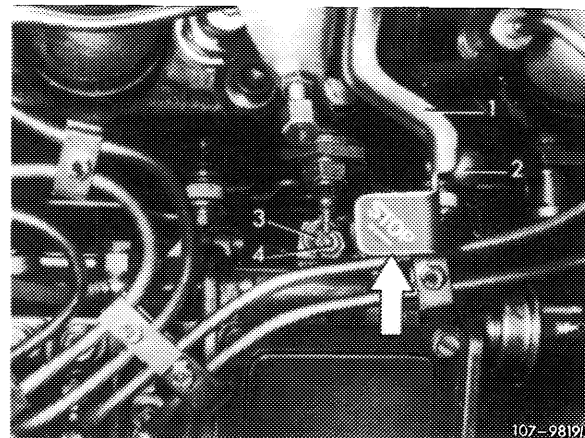

- 1 Push rod
- 2 Slide rod
- 3 Pull rod
- 4 Adjusting ring

6 Vehicles with automatic transmission:

a) Adjust push rod (1) to 252 mm and pull rod (3) to 225 mm, measured from center to center of ball head, and attach.

Attention!

Pull rod (3) should be covered with an insulating hose.

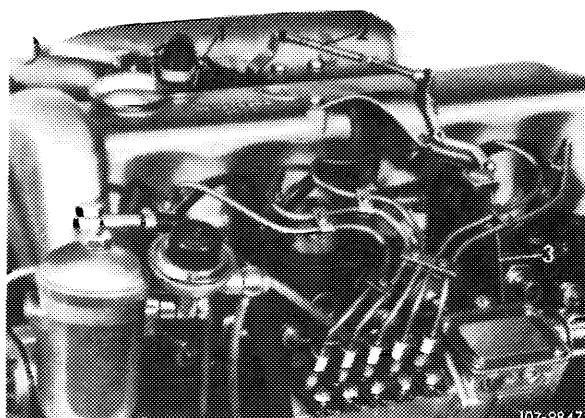

b) Adjust slide rod (2) in **completely extended condition** to a length of 158 mm, measured from center of ball head, and attach.

Note: For attachment, the slide rod need not be completely pulled out.

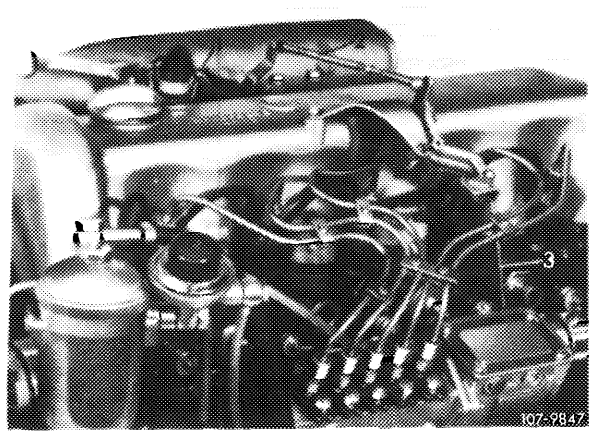

c) Check full throttle stop. With the engine stopped, step down on accelerator pedal from inside vehicle up to stop on kickdown switch. Accelerator pedal and regulating lever (1) should rest against full throttle stop (Fig. item 3). Adjust regulating shaft (6), if required. For this purpose, loosen hex screw (7), pull accelerator pedal slightly up and tighten hex screw again. Check full throttle stop once again and repeat adjustments, if required.

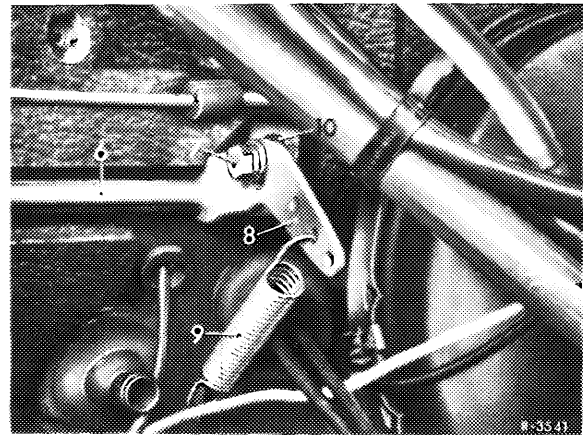

Attention!

If the regulating linkage is not moving to full throttle, check whether shaped spring for idle speed adjuster is correctly installed.

- 1 Cable control for idle speed increase
- 2 Shaped spring
- 3 Adjusting ring
- 4 Guide lever

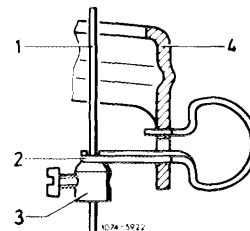

d) Adjust control pressure rod.

Attention!

Due to working pressure control (proportional to engine torque) it is extremely important that the control pressure rod is correctly adjusted.

A wrongly adjusted control pressure rod will lead to a reduction of the working pressure and will thereby make the gears ineffective.

Accelerate to full throttle by means of guide lever (not kickdown). Disconnect control pressure rod (4) and pull **completely forward** to full throttle stop. Adjust control pressure rod with ball socket in such a manner that it can be pushed on ball head of guide lever (5) free of tension.

- 1 Push rod
- 4 Control pressure rod
- 5 Guide lever

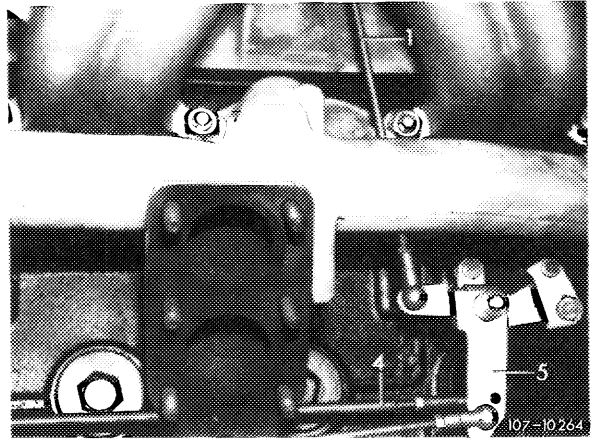

e) Adjust Bowden wire for Tempomat (cruise control). For this purpose, push shutoff lever up to stop. Bowden wire should rest against regulating lever free of tension. Adjust Bowden wire with adjusting nut (arrow), if required. Release shutoff lever (idle speed position). In this position, Bowden wire is slack.

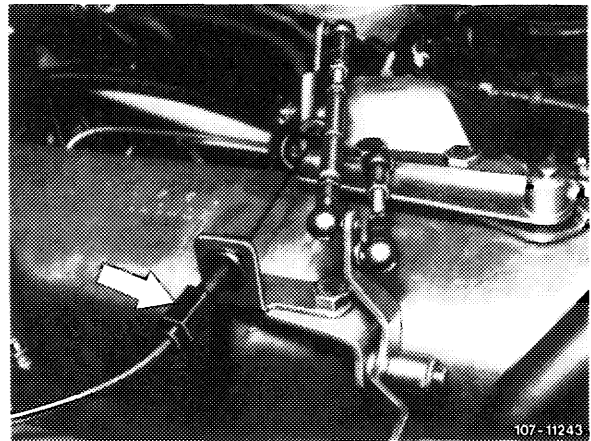

7 Check function of emergency stop button. Run engine at idle speed, push emergency stop button (arrow). Engine should shut off. Readjust pull rod (2), if required.

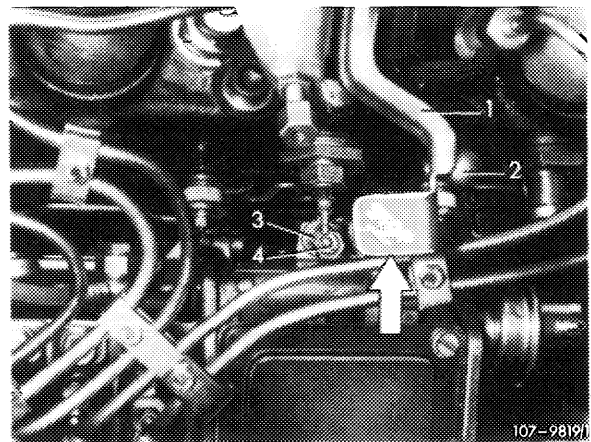

Engine regulation
 Engine 617 in model 115.1
 MW-injection pump with mechanical governor

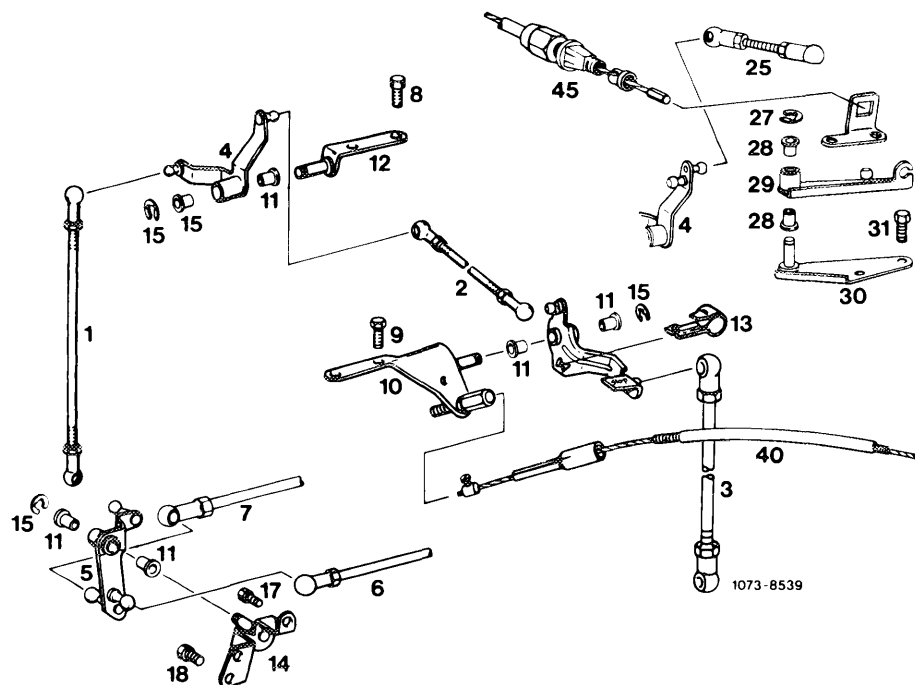

- | | | |
|--|---|--------------------|
| 1 Push rod | 11 Plastic bushing | USA version |
| 2 Connecting rod | 12 Bearing | 25 Connecting rod |
| 3 Pull rod | 13 Shaped spring | 26 Holder |
| 4 Guide lever | 14 Bearing | 27 Lock |
| 5 Intermediate lever | 15 Lock | 28 Plastic bushing |
| 6 Connecting rod to front wall
regulating shaft | 16 Angle lever | 29 Guide lever |
| 7 Control pressure rod | 17 Hex screw | 30 Holder |
| 8 Hex screw | 18 Hex screw | 31 Hex screw |
| 9 Hex screw | 40 Bowden wire for idle speed adjuster | |
| 10 Holder | 45 Bowden wire for Tempomat
(cruise control) | |

C. Engine 616, 617 in model 123.1
 with MW-injection pump
 Standard version and (AUS) (J) (S)
 (USA) up to 1979

Length of regulating linkage

Connecting rod (2) from guide lever to
 regulating lever on cylinder head cover 122 mm
 (manual transmission)

Connecting rod (1) from regulating lever
 on cylinder head cover to regulating lever 327 mm
 on cylinder crankcase

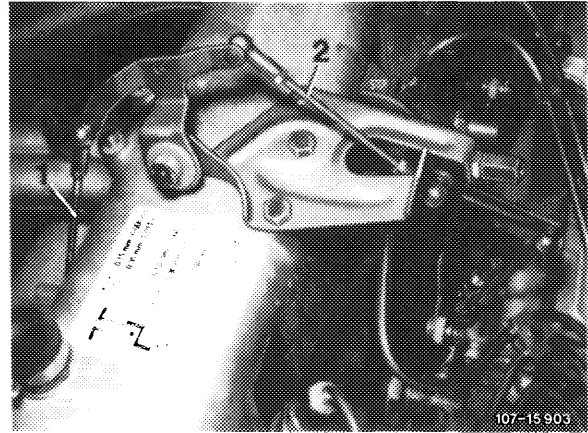

Adjusting

1 Check regulating linkage for easy operation and distortion. Replace damaged parts, if required.

2 Disconnect all regulating rods.

3 Check whether regulating lever (1) of injection pump rests against idle speed stop (3).

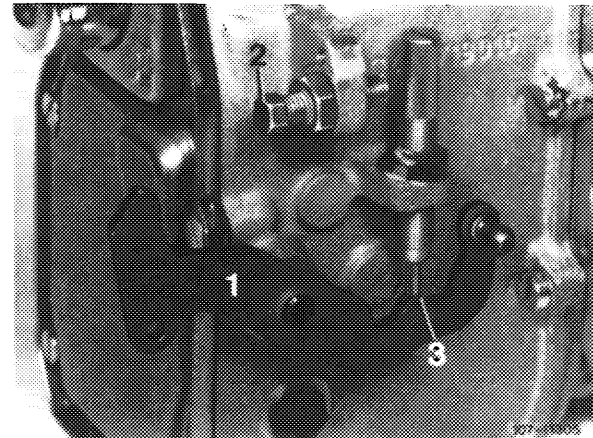

- 1 Regulating lever
- 2 Full throttle stop
- 3 Idle speed stop

4 Vehicles with manual transmission:

a) Adjust pull rod (3). For this purpose, push shutoff lever (arrow) to stop. Adjust pull rod in such a manner that there are 5–6 mm (distance "a") play between bottom edge of ball head and upper edge of ball socket. Attach pull rod.

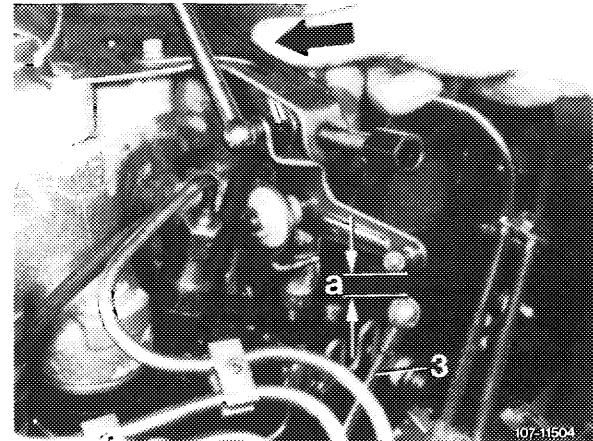

- 3 Pull rod
- Distance "a" = 5–6 mm

b) Adjust connecting rod (1 and 2) to 122 mm or 327 mm, measured from center to center of ball head, and attach.

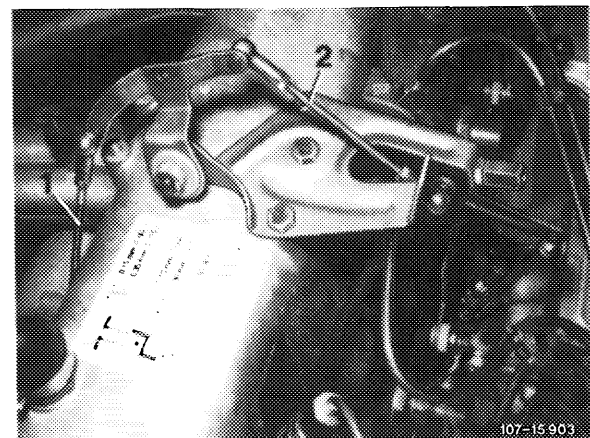

- 1 Connecting rod
- 2 Connecting rod

c) Check full throttle stop. With the engine stopped, step on accelerator pedal from inside vehicle up to stop. Accelerator pedal and regulating lever (1 in Fig. item 3) should rest against full throttle stop. Adjust regulating shaft (6), if required. For this purpose, loosen hex screw (7), pull accelerator pedal slightly up and tighten hex screw again. Check full throttle stop once again and repeat adjustments, if required.

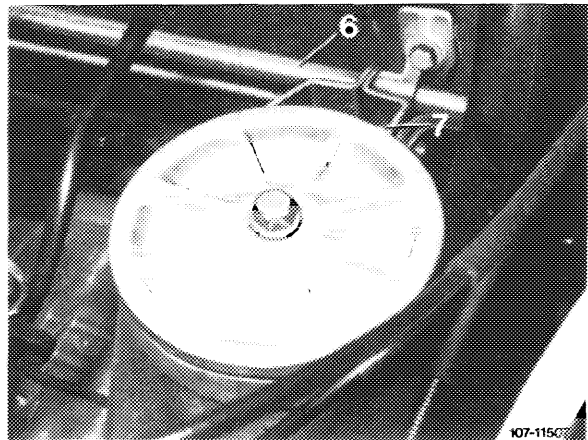

Attention!

If the regulating linkage is not moving to full throttle, check whether shaped spring (arrow) for idle speed adjuster is correctly installed.

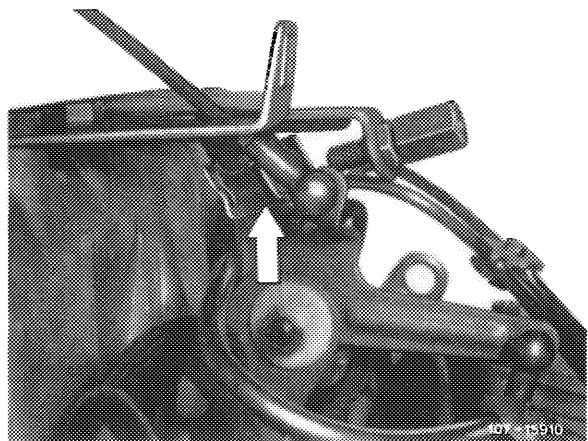

5 Vehicles with automatic transmission:

a) Adjust pull rod (3). For this purpose, push shutoff lever (arrow) against stop. Adjust pull rod in such a manner that the play between bottom edge of ball head and upper edge of ball socket is 5–6 mm (distance "a"). Attach pull rod.

Attention!

On engine 616, pull rod (3) should be covered with an insulating hose.

3 Pull rod
Distance "a" = 5–6 mm

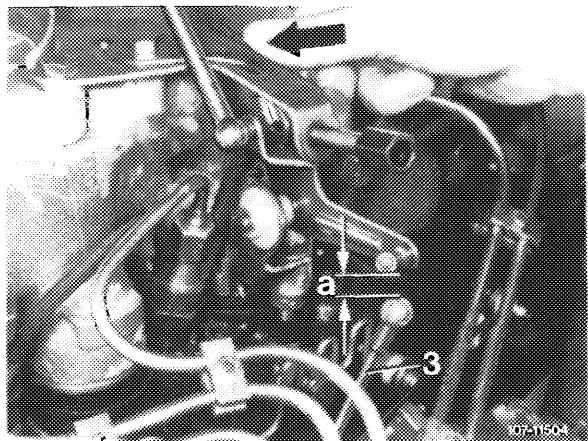

b) Adjust connecting rod (1) to 327 mm, measured from center to center of ball head, and attach.

c) Attach idle path rod (2).

1 Connecting rod
2 Idle path rod

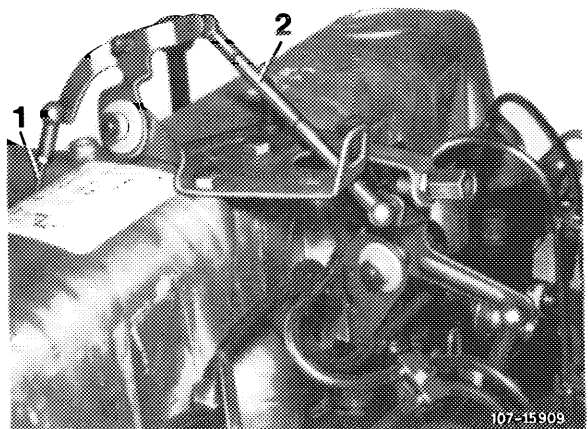

d) Check full throttle stop. With engine switched off, step on accelerator pedal from inside vehicle down to stop on kickdown switch. The accelerator pedal and the regulating lever (1 in Fig. item 3) should rest against full throttle stop. Adjust regulating shaft (6) if required. For this purpose, loosen hex screw (7), pull accelerator pedal slightly up and tighten hex screw again. Check full throttle stop again and repeat adjustments, if required.

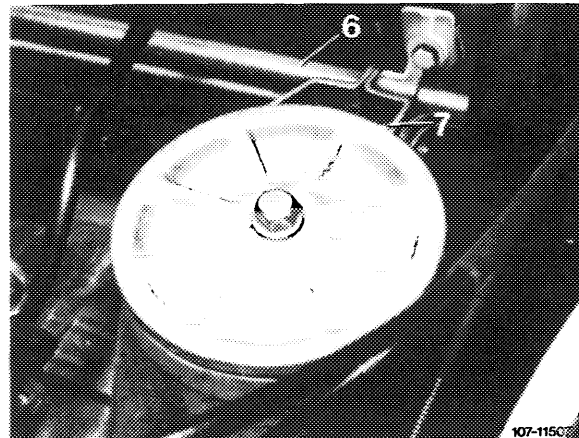

Attention!

If regulating linkage is not moving to full throttle, check whether shaped spring (arrow) for idle speed adjuster is correctly installed.

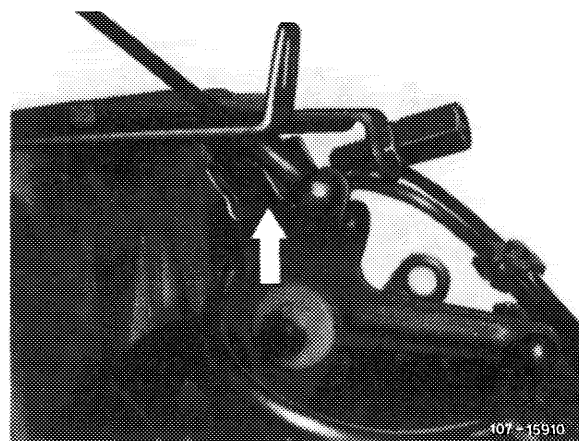

e) Adjust control pressure rod.

Attention!

Since the working pressure is regulated via the control pressure rod it is extremely important that it is adjusted as instructed. A wrongly adjusted control pressure rod will change the working pressures and thereby damage the gear assembly.

Engine 616

Note

The control pressure rod is attached to slot (arrow) of regulating lever (1) on injection pump.

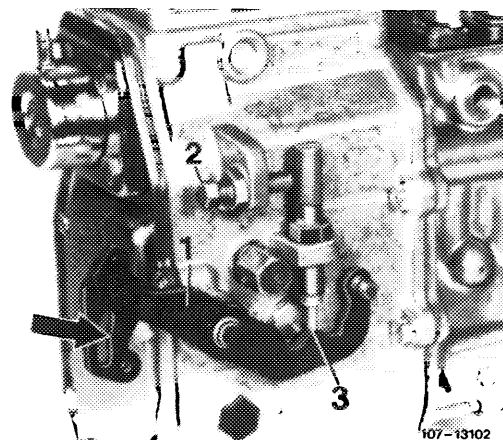

Loosen clamping screw (1) on control pressure rod (3).

Apply full throttle from direction of guide lever on cylinder head cover. Regulating lever should rest against full throttle stop on injection pump and control pressure rod against full throttle stop of automatic transmission.

Tighten clamping screw (1) again.

Note: Compression spring (2) pulls the control pressure rod to full throttle.

- 1 Clamping screw
- 2 Compression spring (covered)
- 3 Control pressure rod

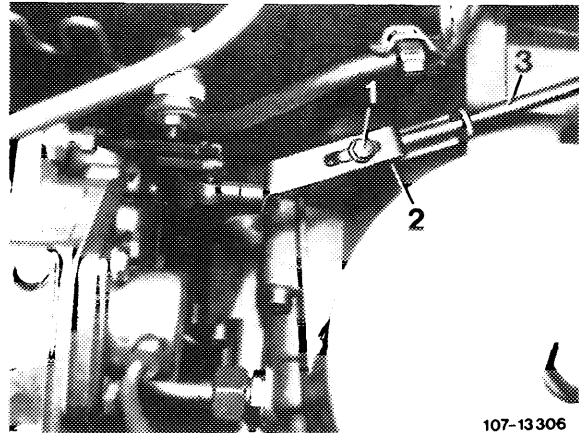

Engine 617

Disconnect control pressure rod (4) and apply full throttle **from direction of guide lever (5)**. Pull control pressure rod **completely forward** to full throttle stop and attach free of tension, adjust if required.

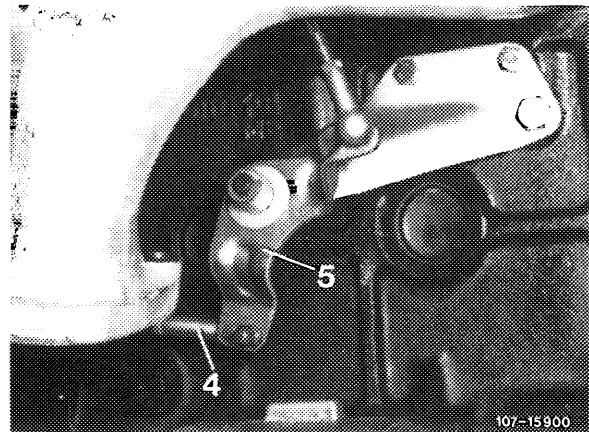

f) Adjust Bowden wire for Tempomat (cruise control). For this purpose, push shutoff lever up to stop position. Bowden wire should rest against regulating lever (arrow). Adjust Bowden wire with adjusting screw (1), if required. Release shutoff lever (idle speed position). In this position, Bowden wire is slack.

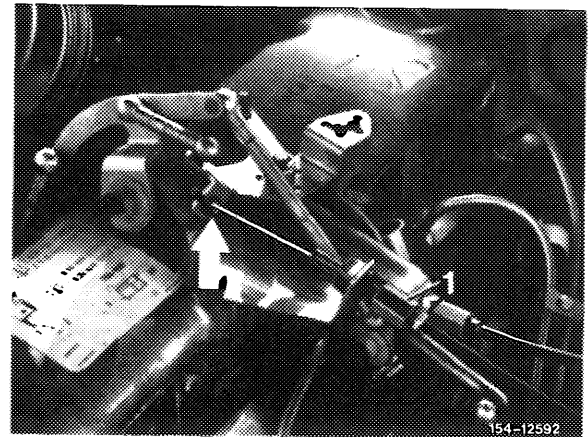

6 Check function of emergency stop button. Run engine at idle speed, push emergency stop button (arrow). Engine should shut off. Readjust pull rod (3), if required.

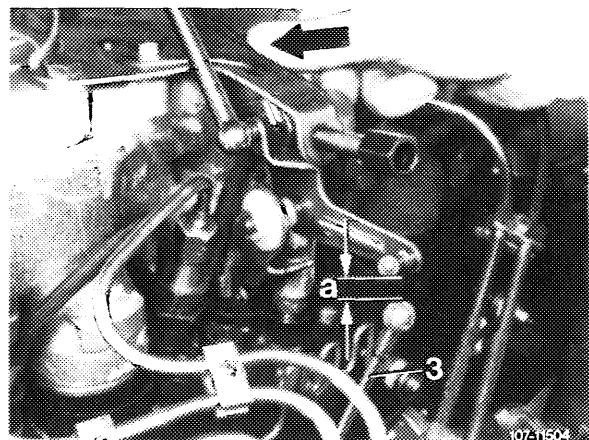

Engine regulation
 Engine 616, 617 in model 123.1
 MW-injection pump with mechanical governor

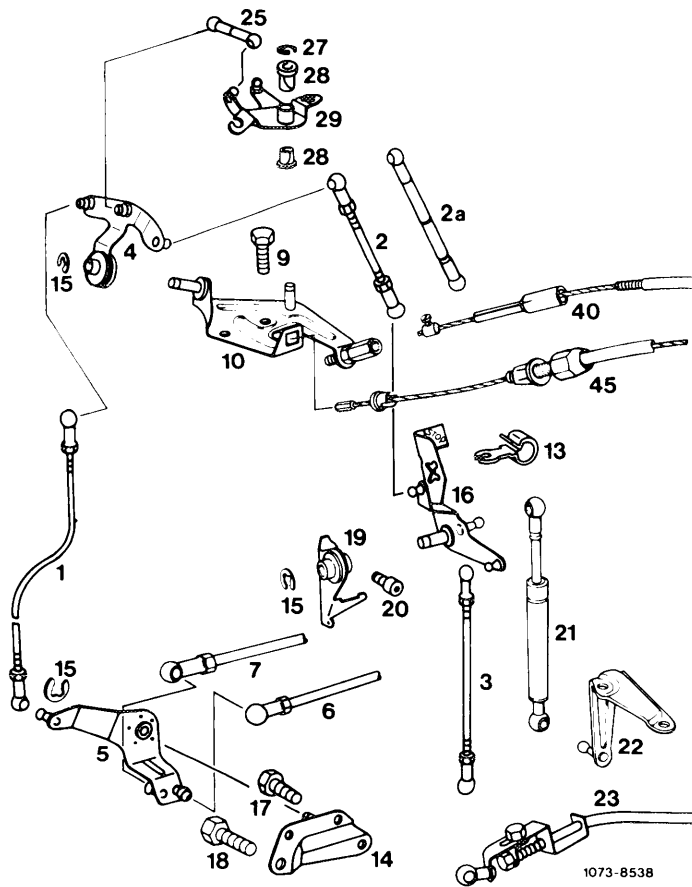

- | | | |
|---|---------------------|--|
| 1 Push rod | 13 Shaped spring | 23 Control pressure rod engine 616 |
| 2 Connecting rod | 14 Bearing | 40 Bowden wire for idle speed adjuster |
| 2a Idle path rod | 15 Lock | 45 Bowden wire for Tempomat (cruise control) |
| 3 Pull rod | 16 Angle lever | |
| 4 Guide lever | 17 Hex screw | USA version |
| 5 Intermediate lever | 18 Hex screw | 25 Connecting rod |
| 6 Connecting rod to front wall regulating shaft | 19 Bearing | 27 Lock |
| 7 Control pressure rod engine 617 | 20 Hex socket screw | 28 Plastic bushing |
| 9 Hex screw | 21 Damper | 29 Guide lever |
| 10 Holder | 22 Holder | |

D. Engine 615, 616, 617 in model 123.1 with M/RSF-injection pump

Length of regulating linkage

Designation	Engine	mm
Push rod (4 in Fig. item 2)	616, 617	180
	615	188
Connecting rod (5 in Fig. item 2)	615, 616, 617	213

Adjusting

- 1 Check regulating linkage for easy operation and distortions. Replace damaged parts, if any.
- 2 Disconnect both regulating rods (4 and 5).

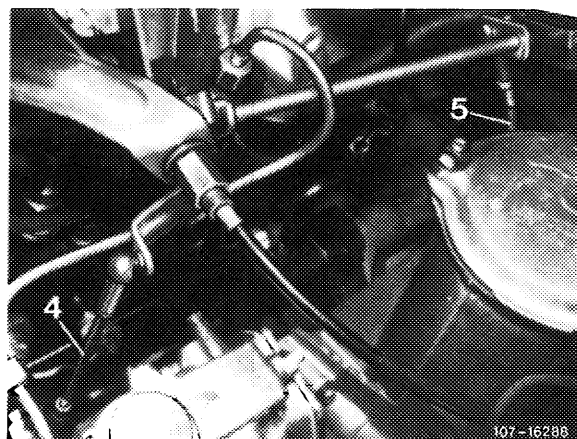

- 3 Set push rod (4) on engine 615 to 188 mm, on engine 616 and 617 to 180 mm, measured from center to center of ball socket and attach.

Attention!

On engine 617, the push rod (4) should be covered with an insulating hose.

- 4 Check full stop position. With engine stopped, step on accelerator pedal from inside vehicle down to stop or on automatic transmission down to stop of kick-down switch. Accelerator pedal and regulating lever should rest against full throttle stop (2). If required, adjust regulating linkage with adjusting screw (arrow) in such a manner that the regulating lever on injection pump (1) rests against full throttle stop (2).

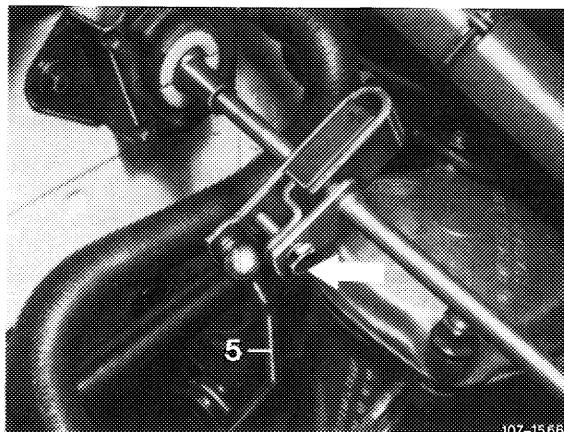

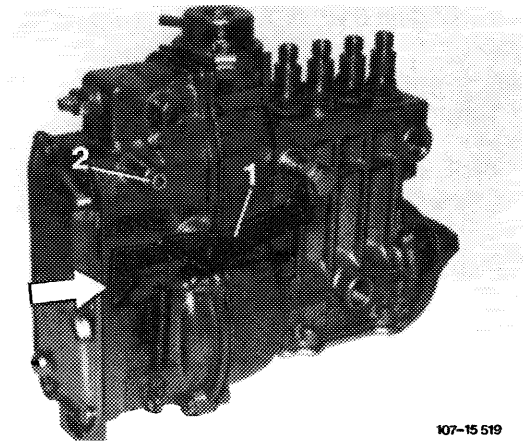

107-15 519

If the full throttle or idle throttle stop is not attained with this adjustment, adjust connecting rod (5) from longitudinal regulating valve to accelerator pedal to 213 mm, measured from center of ball socket to center of damping ring and attach.

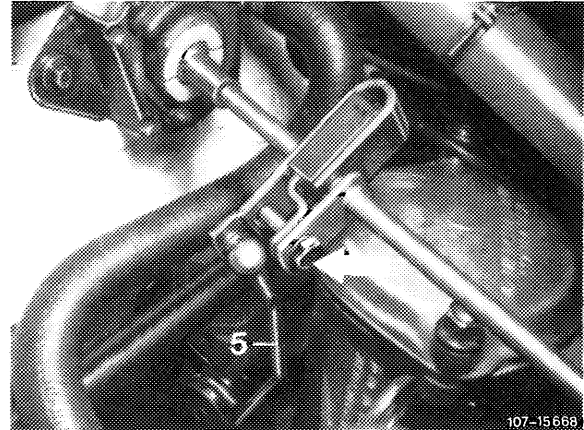

107-15 668

6 Vehicles with automatic transmission. Adjust control pressure rod as follows:

Engine 616 1st version

The control pressure rod is attached to bore (arrow) of regulating lever (1) on injection pump.

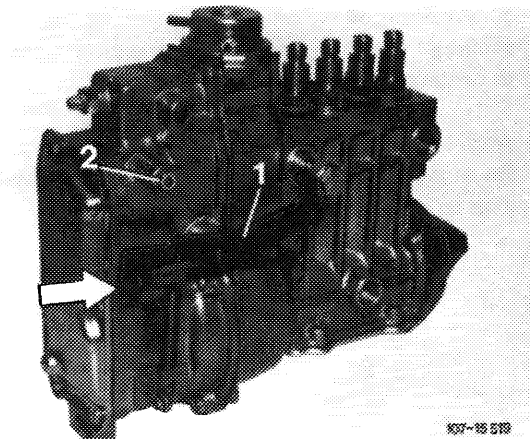

107-15 519

Loosen clamping screw (1) on control pressure rod (3). Apply full throttle from direction of guide lever on cylinder head cover. Regulating lever should rest against full throttle stop on injection pump and the control pressure rod against full throttle stop of automatic transmission.

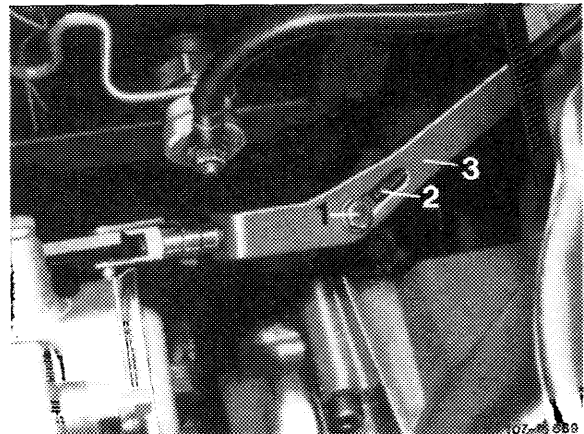

107-15 668

Tighten clamping screw (1) again.

Note: Compression spring (2) will pull control pressure rod also to full throttle.

Engine 615, 617
Engine 616 2nd version

Note: These engines have no control pressure rod. A vacuum control valve is mounted to injection pump instead.

Start of series

Model	Engine	Starting engine end No. automatic transmission	Starting chassis end No.
123.120	615.940	004749	146687
123.102			
123.103	616.912	027799	109714
123.123			
123.125			
123.183			003661
123.105			
123.130			165193
123.132			165258
	617.912	085716	
123.150			004950
123.190			011087

Length of regulating linkage

Idle path rod (7) in extended condition	154 mm
Pull rod (8)	137 mm

1 Disconnect all regulating rods.

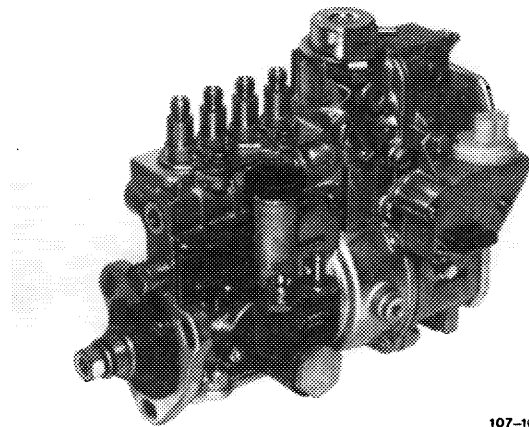

107-16128

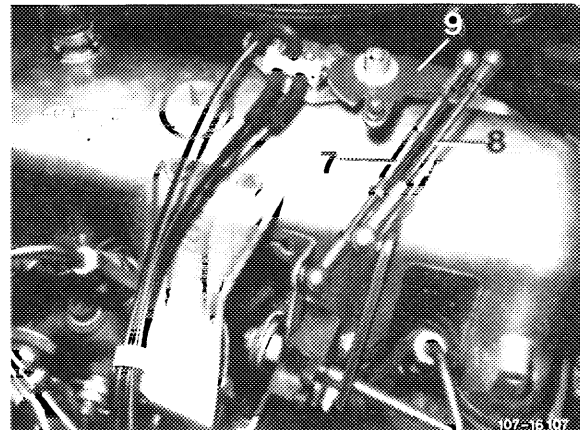

107-16 107