

Specified viscosity classes
acc. to SAE for continuous outside temperatures

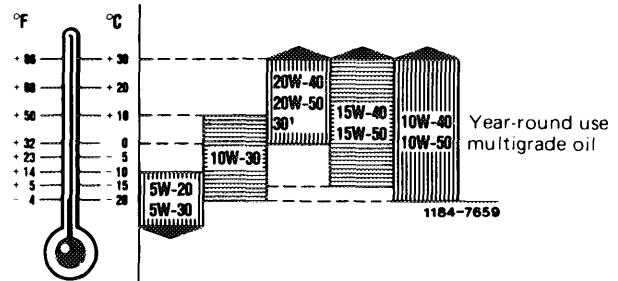

SAE 40 may be used if ambient temperatures constantly exceed +30° C (+86° F).

Oil capacity in liters (For approved engine oil types refer to „Specifications for Service Products“)

Total capacity during oil and filter change	8.0
Oil pan	approx. 7.0
Oil dipstick color code	black
Tightening torques	Nm (kpm)
Oil drain plug on oil pan	50 (5)
Fastening screw for oil filter bowl	40 (4)

Special tool

Socket/box wrench 14 x 17 mm



000 589 24 07 00

Conventional tool

Wrench insert 14 mm, 1/2 mm

e.g. made by Hazet, D-5630 Remscheid, no. 985-14

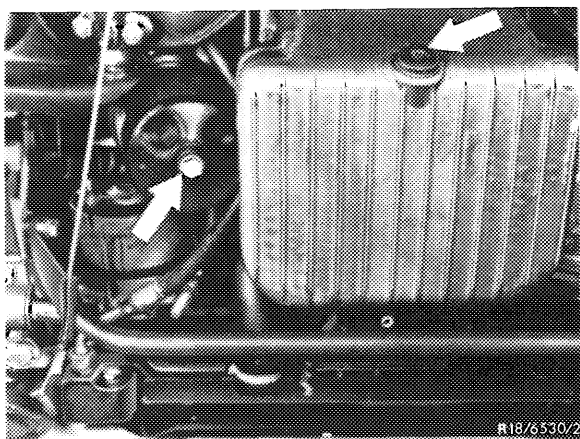

- With engine at operating temperature, drain engine oil from oil pan.

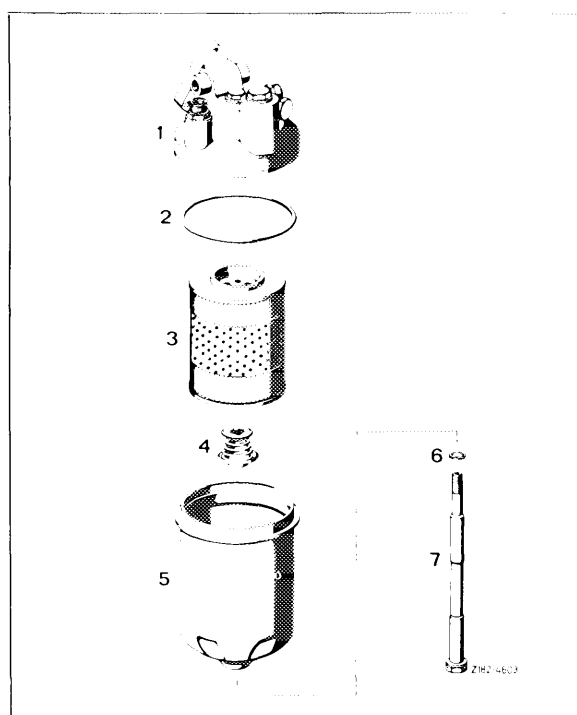

- Unscrew oil filter bowl (5) and empty.
- Wash out oil filter bowl and blow out.
- Check sealing ring (6) and renew if found necessary.

For this purpose pull pressure spring with spring plate (4) from hex. screw (7). When reassembling, **the pressure spring with spring plate must not be forgotten or wrongly installed, under any circumstances.**

- Renew rubber sealing ring (2).
- Fit **new** paper filter element (3) into oil filter bowl.

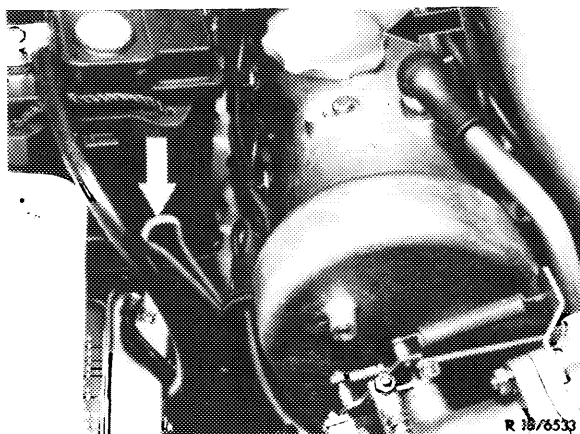

- Renew sealing ring on drain plug.
- Tighten drain plug to 50 Nm (5 kpm).
- Fill with engine oil.
- Run engine and check for leaks.
- Check oil level with the engine switched off.

**Specified viscosity classes
acc. to SAE for continuous outside temperatures**

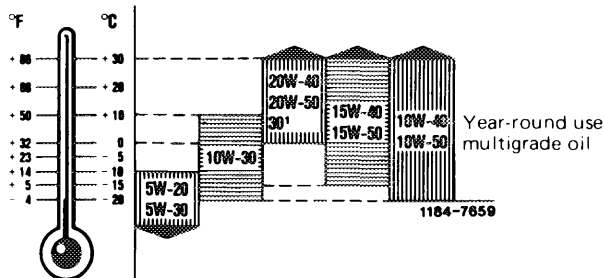

SAE 40 may be used if ambient temperatures constantly exceed +30° C (+86° F).

Oil capacity in liters (For approved engine oil types refer to „Specifications for Service Products“)

Total capacity during oil and filter change	11
Capacity without filter change	10
Tightening torques	Nm (kpm)
Oil drain plug on oil pan	50 (5)
Fastening screw for oil filter bowl	40 (4)

Special tools

Telethermometer for measuring engine oil temperature



116 589 27 21 00

Socket/box wrench 14 x 17 mm



000 589 24 07 00

Conventional tool

Wrench insert 14 mm, 1/2" square

e.g. made by Hazet, D-5630 Remscheid, no. 985-14

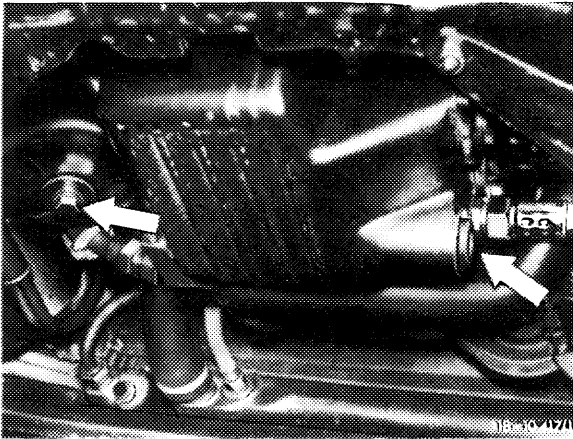

- Drain engine oil from oil pan with engine at operating temperature. For this purpose, open **closing cover** of supply tank.

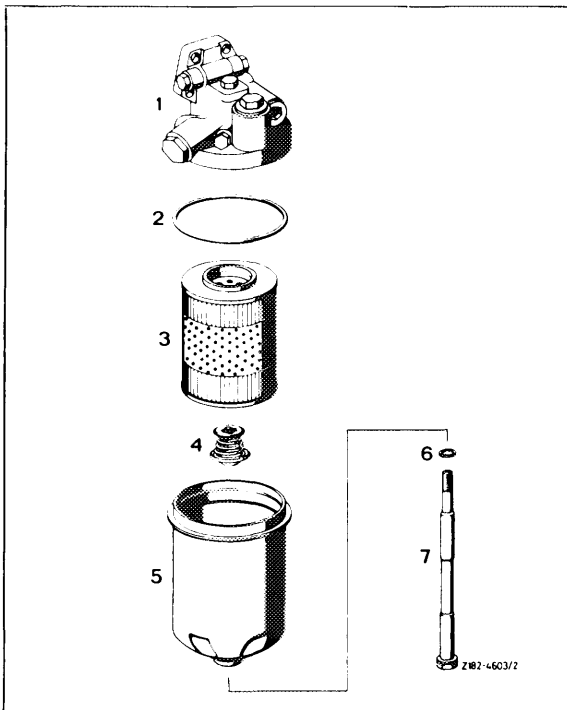

- Unscrew oil filter bowl (5) and drain.
- Wash oil filter bowl and blow out.
- Check sealing ring (6) and renew according to condition.

For this purpose, pull compression spring with spring retainer (4) from hex. screw (7). **Never forget or install compression spring with spring retainer wrongly** during assembly.

- Renew rubber sealing ring (2).
- Mount oil filter bowl with a **new** paper filter insert (3).
- Renew sealing ring on drain plug.
- Tighten drain plug to 50 Nm (5 kpm).
- Fill engine oil into supply tank.
- Run engine and check for leaks.
- Check oil level with the engine **running**.

The engine should have an idle speed of approx. 600/min. and an **oil temperature of approx. 80° C (176° F)**.

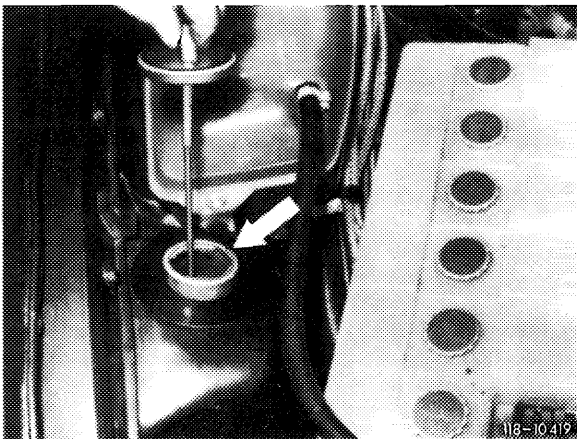

Engine oil and filter change

Revision: New oil dipstick (yellow-green) added

Engine 110

**Specified viscosity classes
acc. to SAE for continuous outside temperatures**

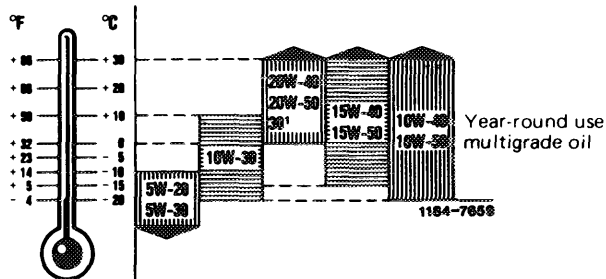

SAE 40 may be used if ambient temperatures constantly exceed +30°C (+86°F).

Oil capacity in litres (for approved engine oils refer to "Specifications for service products")

Oil dipstick color code	pink (brown ¹⁾ wine red	yellow green
Total filling capacity during oil and filter change	6.5	6.0
Oil pan	6.0	5.5

¹⁾ USA version model years 1975/76.

Tightening torques

		Nm	(kpm)
Oil drain plug on oil pan	M 26	50	(5)
	M 12	40	(4)
Fastening screw for oil filter bowl		40-45	(4-4.5)

Special tool

Socket/box wrench 14 x 17 mm



000 589 24 07 00

Conventional tool

Wrench insert 14 mm, 1/2" square

e.g. made by Hazet, D-5630 Remscheid, Order No. 985-14



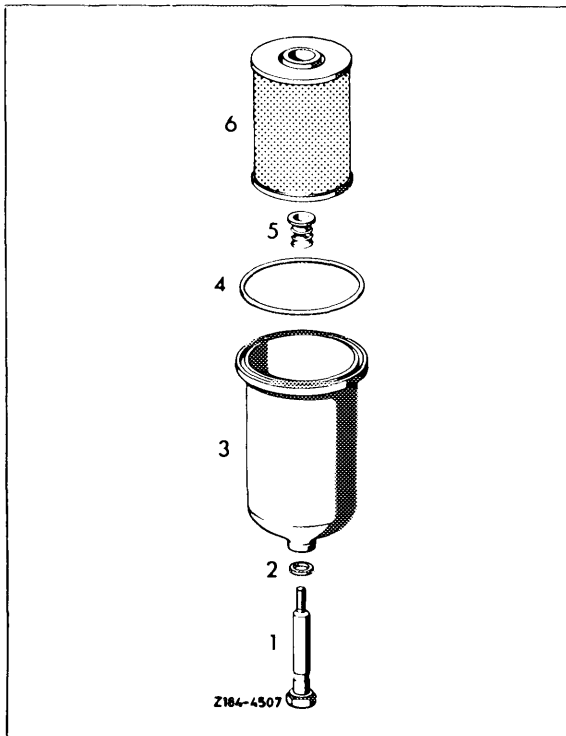
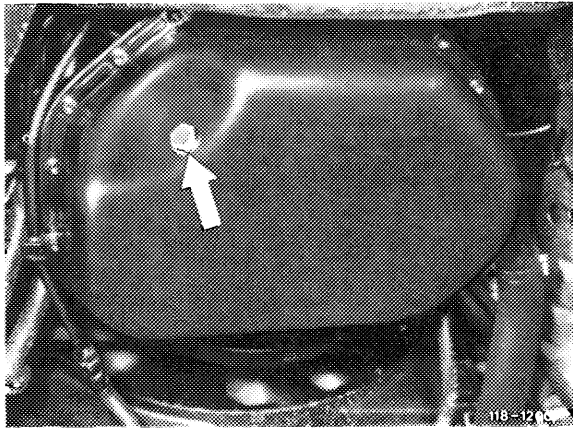
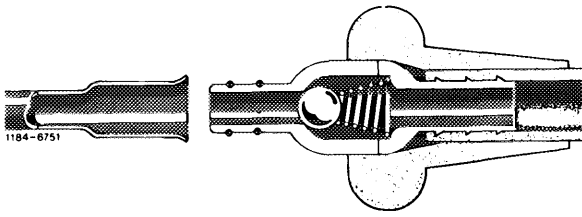

On engines with tulip-shaped oil dipstick-guide tube:

- Draw off engine oil with engine at operating temperature.

If no drawing-off unit is available or if the engine is not equipped for such a purpose:

- Drain engine oil from oil pan.

- Unscrew oil filter bowl (3) and empty.
- Wash out oil filter bowl and blow out.
- Check sealing ring (2) and renew according to condition.

For this purpose, pull compression spring with spring retainer (5) from hex. screw (1). During assembly, **never forget compression spring with spring retainer or install wrongly.**

- Replace rubber sealing ring (4).
- Mount oil filter bowl with a **new** paper filter element (6).
- If oil has been drained from oil pan, replace sealing ring on oil drain plug.

- Tighten drain plug.
- Fill with engine oil.
- Run the engine and check for leaks.
- Check oil level with the engine switched off.

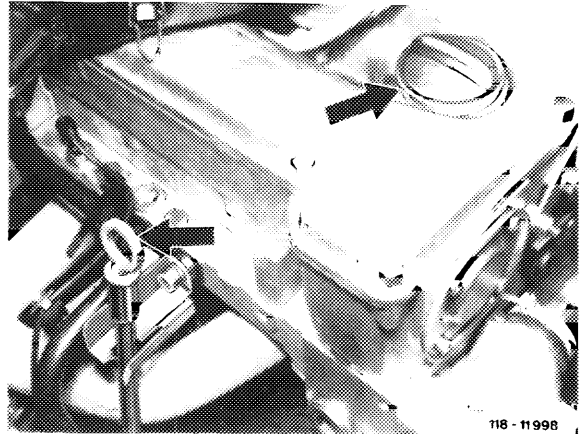

**Specified viscosity classes
acc. to SAE for continuous outside temperatures**

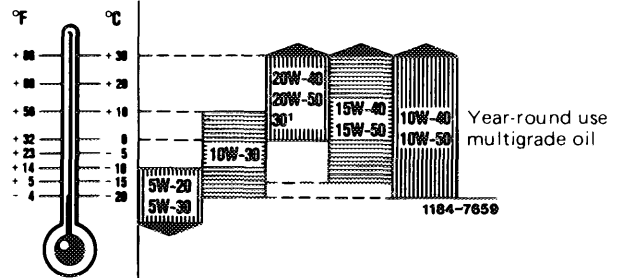

SAE 40 may be used if ambient temperatures constantly exceed +30° C (+86° F).

Oil capacity in liters (For approved engine oil types refer to „Specifications for Service Products“)

	1st version Smooth oil pan bottom	2nd version Profiled oil pan bottom
Total capacity during oil and filter change	6.0	6.5
Oil pan	5.5	6.0

Oil dipstick color code	pink
--------------------------------	------

Tightening torques		Nm	(kpm)
Oil drain plug on oil pan	M 26	50	(5)
	M 12	40	(4)
Fastening screw for oil filter bowl		40–45	(4–4.5)

Special tool

Socket/box wrench 14 x 17 mm		000 589 24 07 00
------------------------------	--	------------------

Conventional tool

Wrench insert 14 mm, 1/2" square	e.g. made by Hazet, D-5630 Remscheid, no. 985-14
----------------------------------	--

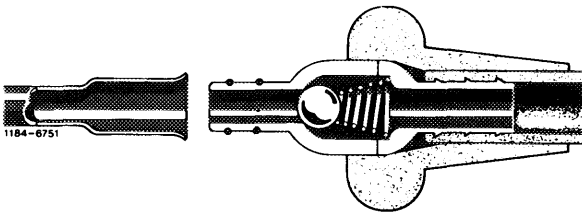

On engines with tulip-shaped oil dipstick-guide tube:

- Draw off engine oil with engine at operating temperature.

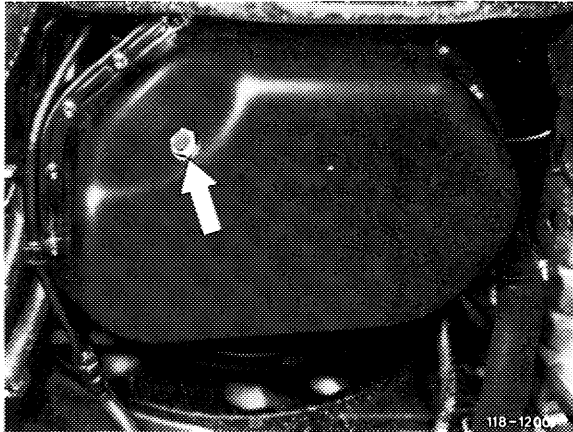

If no drawing-off unit is available or if the engine is not equipped for such a purpose:

- Drain engine oil from oil pan.

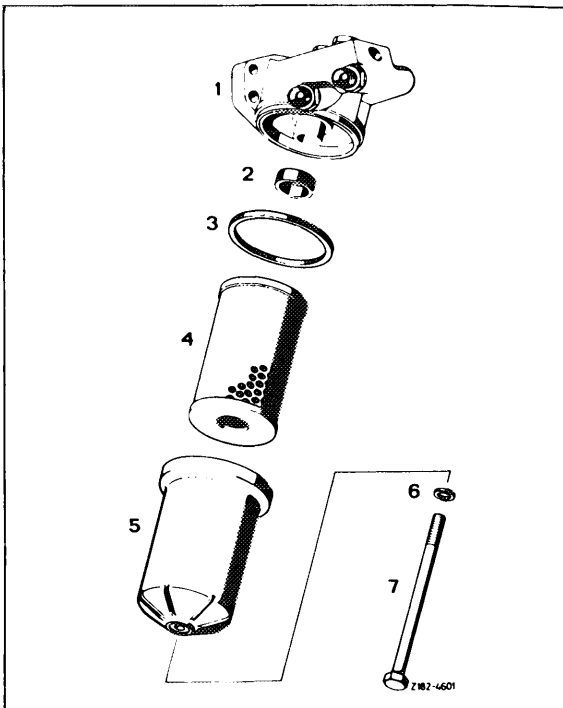

- Unscrew oil filter bowl (5) and drain.
- Wash oil filter bowl and blow out.
- Check sealing ring (6) and renew if found necessary.
- Renew rubber sealing ring (3).
- Check rubber sealing ring (2) for hardening and damage, renew if found necessary.
- Mount oil filter bowl with a **new** paper filter element.

**Specified viscosity classes
acc. to SAE for continuous outside temperatures**

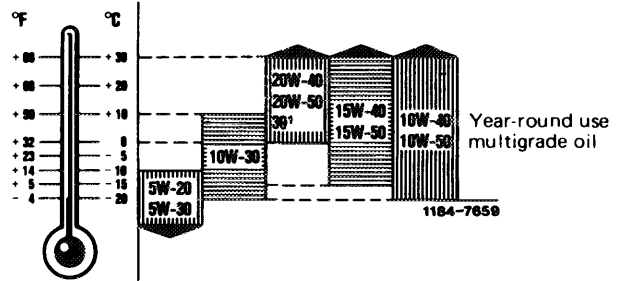

SAE 40 may be used if ambient temperatures constantly exceed +30° C (+86° F).

Oil capacity in liters (For approved engine oil types refer to „Specifications for Service Products“)

Engine	115 in model 115			115 in model 123
	1st version 115.920 115.923 up to chassis end No. 049764 051864	2nd version 115.920 115.923 from chassis end No. 049765 051865	115.951 and 3rd version 115.923 from chassis end No. 200001	
Total capacity during oil and filter change	4.5	5.0	5.5	5.5
Oil pan	4.0	4.5	5.0	5.0

Oil dipstick color code

Engine 115 in model 115	red
Engine 115 in model 123	yellow

Tightening torques

	Nm	(kpm)
Oil drain plug on oil pan	M 26	50 (5)
	M 12	40 (4)
Fastening screw for oil filter bowl	40–45	(4–4.5)

Special tool

Socket/box wrench 14 x 17 mm		000 589 24 07 00
------------------------------	--	------------------

Conventional tool

Wrench insert 14 mm, 1/2" square	e.g. made by Hazet, D-5630 Remscheid, no. 985-14
----------------------------------	--



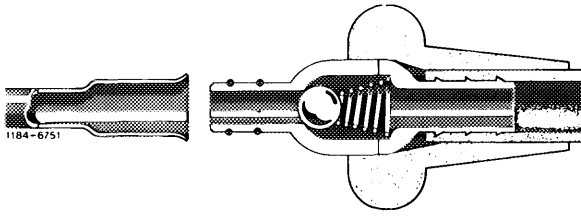

On engines with tulip-shaped oil dipstick-guide tube:

- Draw off engine oil with engine at operating temperature.

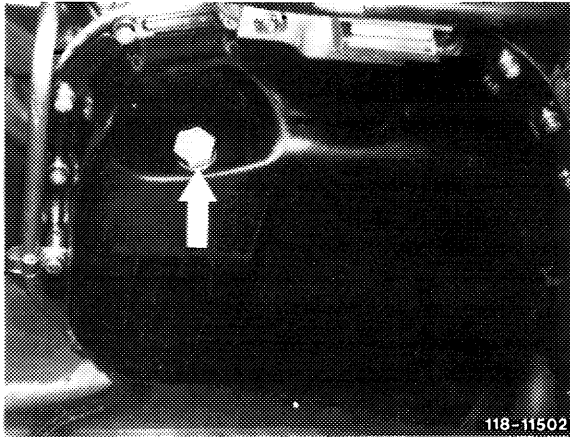

If no drawing-off unit is available or if the engine is not equipped for such a purpose:

- Drain engine oil from oil pan.

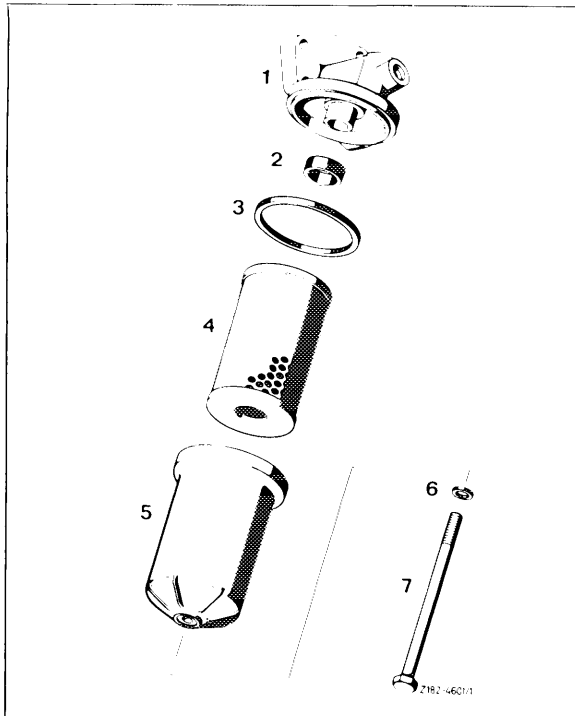

- Unscrew oil filter bowl (5) and drain.
- Wash oil filter bowl and blow out.
- Check sealing ring (6) and renew if found necessary.
- Renew rubber sealing ring (3).
- Check rubber sealing ring (2) for hardening and damage, renew if found necessary.
- Mount oil filter lower half with a **new** paper filter element.

- If oil has been drained from oil pan, replace sealing ring on oil pan drain plug.
- Tighten drain plug.
- Add engine oil.
- Run engine and check for leaks.
- Check oil level with engine stopped.

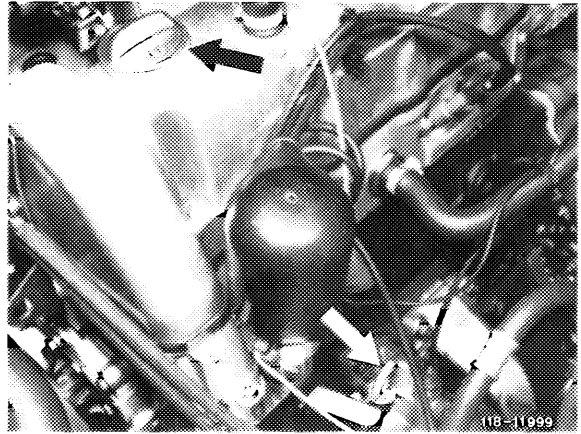

Revision: Engine 117.986 added.

Engines 116 117

**Specified viscosity classes
acc. to SAE for continuous outside temperatures**

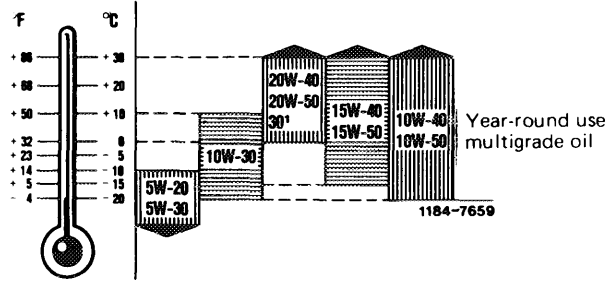

¹⁾ SAE 40 may be used if ambient temperatures constantly exceed +30° C (+86° F).

Oil capacity in liters (For approved engine oil types refer to „Specifications for Service Products“)

Total capacity during oil and filter change	8.0
Oil pan	7.5

Oil dipstick color code

116.980/981 with single-piece oil pan, 117.981	yellow
116.980, 117.983/984/986 with split oil pan	light blue
117.982/985	gentian blue

Tightening torques

		Nm	(kpm)
Oil drain plug on oil pan	M 26	50	(5)
	M 12	40	(4)
Fastening screw for oil filter housing		40–45	(4–4.5)

Special tool

Socket/box wrench 14 x 17 mm



000 589 24 07 00

Conventional tool

Wrench insert 14 mm, 1/2" square

e.g. made by Hazet, D-5630 Remscheid, no. 985-14



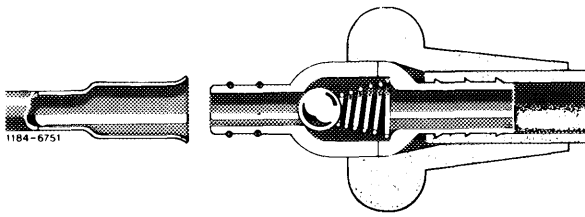

On engine with tulip-shaped oil dipstick-guide tube:

- Draw off engine oil with engine at operating temperature.

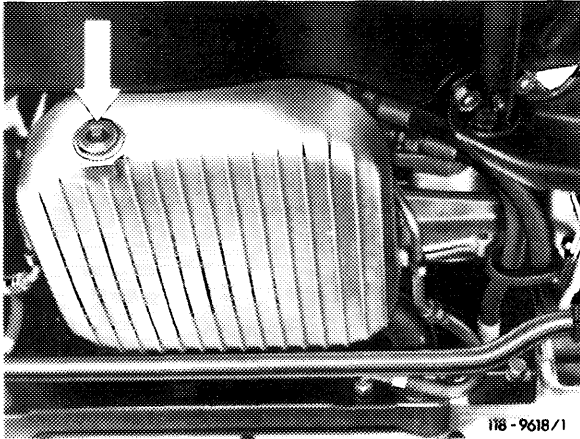

If no drawing off unit is available or if the engine is not equipped for such a purpose:

- Drain engine oil from oil pan.

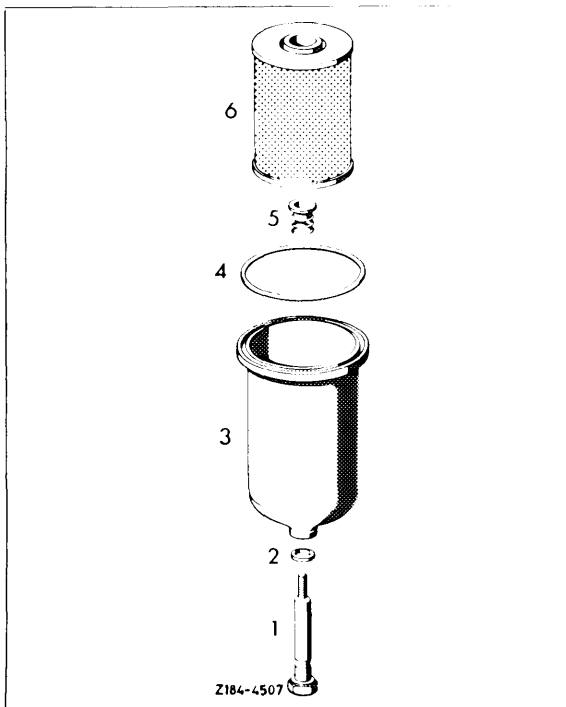

- Unscrew oil filter housing (3) and empty.
- Wash out oil filter housing and blow out.
- Check sealing ring (2) and renew if found necessary.

For this purpose pull pressure spring with spring plate (5) from hex. screw (1). **The pressure spring with spring plate must under no circumstances be omitted or wrongly installed** when reassembling.

- Renew rubber sealing ring (4).
- Fit **new** paper filter element into oil filter housing.

- If oil has been drained from oil pan, replace sealing ring on oil pan drain plug.
- Tighten drain plug to 50 Nm (5 kpm).
- Fill with engine oil.
- Run the engine and check for leaks.
- Check oil level with the engine switched off.

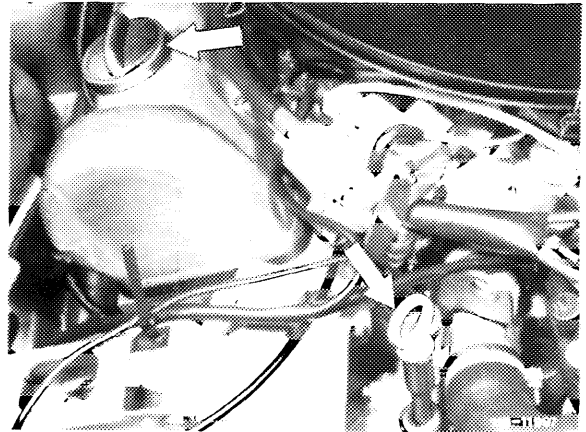

Engines 615 616 617
in model 115
Up to model year 1976

**Specified viscosity classes
acc. to SAE for continuous outside temperatures**

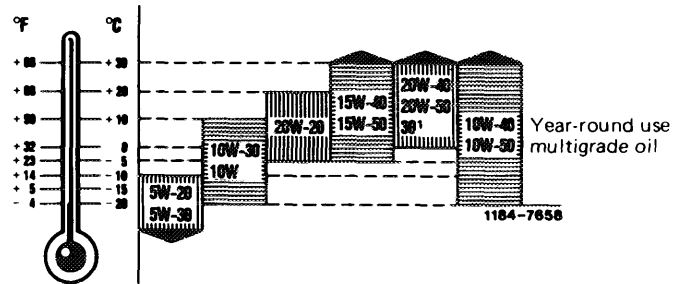

SAE 40 may be used if ambient temperatures constantly exceed +30°C (+86°F).

Oil capacity in liters (For approved engine oil types refer to „Specifications for Service Products“)



Engine	615		616	617
	1st version 615.912 615.913 up to chassis end No. 120829 056238	2nd version 615.912 615.913 from chassis end No. 120830 056239	and 3rd version 615.912 615.913 from chassis end No. 400001 200001	
Total capacity during engine oil and filter change	5.0	5.5	6.0	6.5
Oil pan	4.0	4.5	5.0	5.5

Oil dipstick color code red

Tightening torques Nm (kpm)

Oil drain plug on oil pan	M 26	50	(5)
	M 12	40	(4)
Fastening screw for oil filter bowl		40-45	(4-4.5)

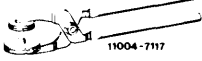
Special tools

Special pliers for cleaning oil filter		110 589 00 68 00
Socket/box wrench 14 x 17 mm		000 500 24 07 00

Conventional tool

Wrench insert 14 mm, 1/2" square e.g. made by Hazet, D-5630 Remscheid, no. 985-14



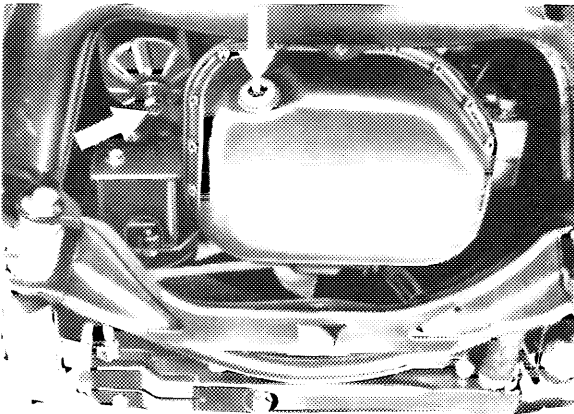

18/6546/2

- Drain engine oil from oil pan with engine at operating temperature.

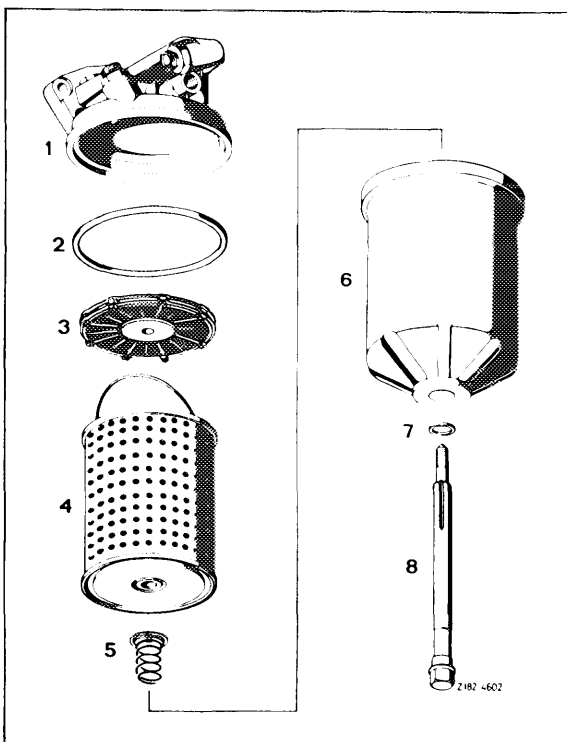

- Remove oil filter bowl (6) and empty.
- Wash out oil filter bowl and blow out.
- Check sealing ring (7) on fixing bolt and renew if found necessary.

For this purpose pull pressure spring with spring plate (5) from hex. bolt (8). When reassembling, **the pressure spring must under no circumstances be omitted or wrongly installed.**

- Renew rubber ring (2).

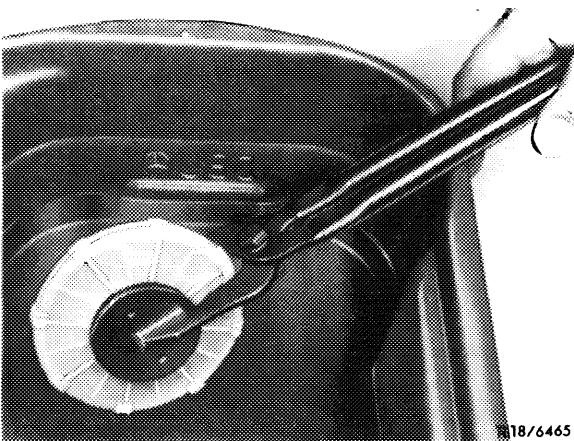

18/6465

- Using the special pliers wash the full flow filter element in cleaning gasoline and blow out in a low pressure air stream.

Engine oil and filter change

- Fit a **new** filter cartridge and the cleaned full flow fine mesh filter element into the filter bowl as in the adjacent figure.

Note: During first inspection (500–1000 km/300–600 miles) replace single-piece initial operation filter element by filter cartridge (4) and main flow screen disc filter element (3) provided with vehicle.

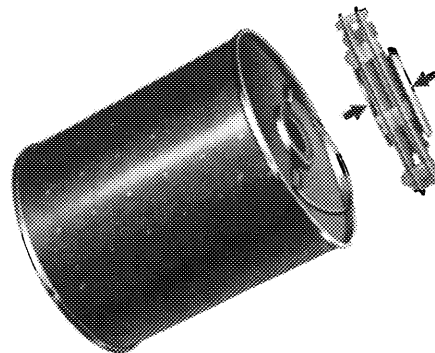

R 07/6660

Filter cartridge and fine mesh filter element

- Replace sealing ring on oil pan drain plug and tighten drain plug.
- Fill with engine oil.
- Run the engine and check for leaks.
- Check the oil level with the engine switched off.

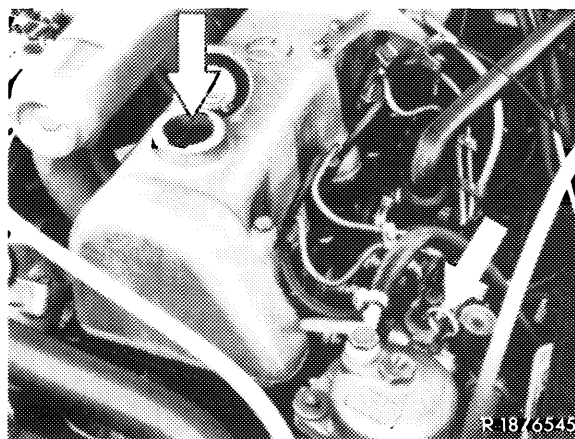

R 18/6545

Engine oil and filter change

Revision: Note concerning filter elements added.

Engines 616 617
in model 123
Starting model year 1977

**Specified viscosity classes
acc. to SAE for continuous outside temperatures**

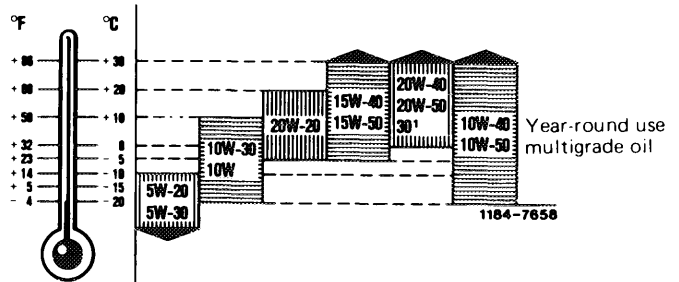

¹⁾ SAE 40 may be used if ambient temperatures constantly exceed +30° C (+86° F).

Oil capacity in liters (For approved engine oil types refer to „Specifications for Service Products“)

Total capacity during oil and filter change	6.5	
Oil pan	5.0	
Oil dipstick color code	red	
Tightening torques	Nm	(kpm)
Central screw – oil filter cover (1st version)	20–25	(2.0–2.5)
Tightening nuts – oil filter cover (2nd version)		
Oil drain plug – oil pan	40	(4)

Special tool

Torque wrench $\frac{3}{8}$ " square,
8–32 Nm (80–320 kpcm)

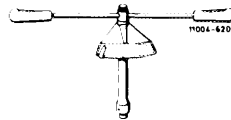

001 589 51 21 00

Note: The filter element (A), Part No. 617 184 00 25, has been replaced by filter element (B), Part No. 617 184 01 25, of engine 617.950 (turbo diesel).

- A Filter element, Part No. 617 184 00 25
Dimension a = 40 mm
- B Filter element, Part No. 617 184 01 25
Dimension b = 55 mm

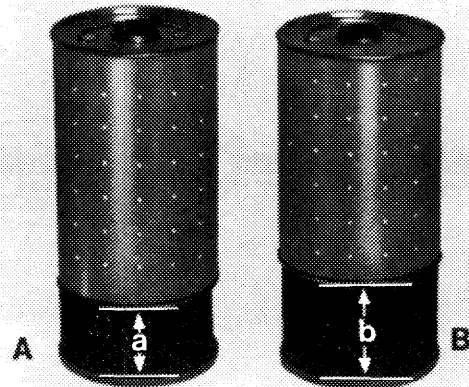

118-13835/2

Prior to extracting or draining the engine oil, drain oil filter. To do so, unscrew the center screw and pull it out approx. 50 mm in the case of the 1st filter version; unscrew nuts and remove cover in the case of the 2nd filter version.

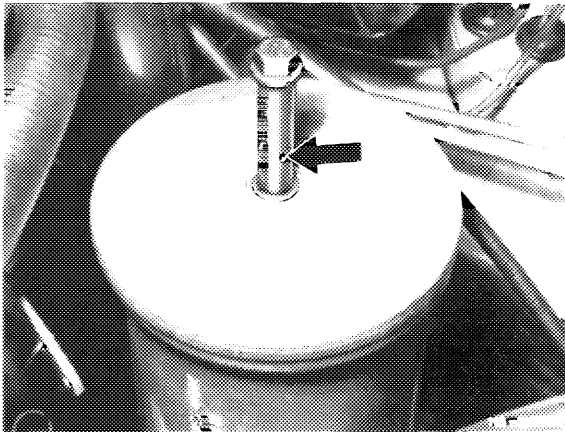

1st version

- Loosen central screw on filter cover and pull out for approx. 50 mm. Throttle bore (arrow) should be visible.

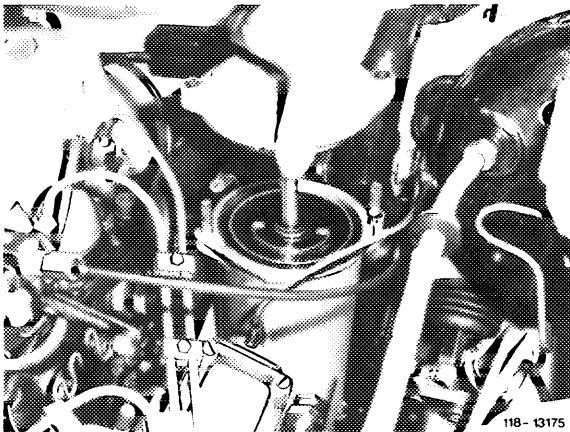

2nd version

- Loosen both nuts and remove filter cover.

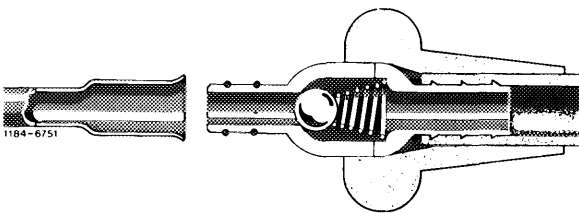

- Draw off engine oil with engine at operating temperature.

If no drawing-off unit is available:

- Drain engine oil from oil pan.

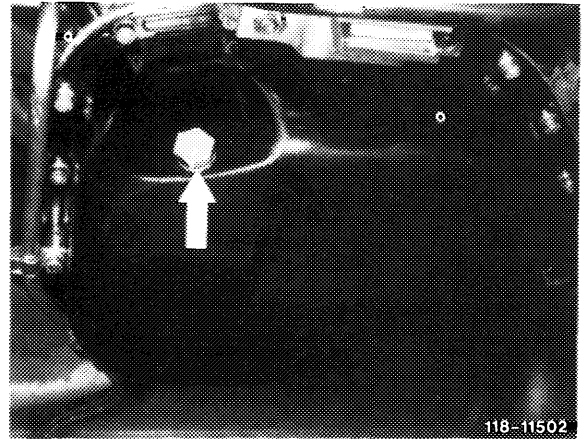

- Replace filter element.

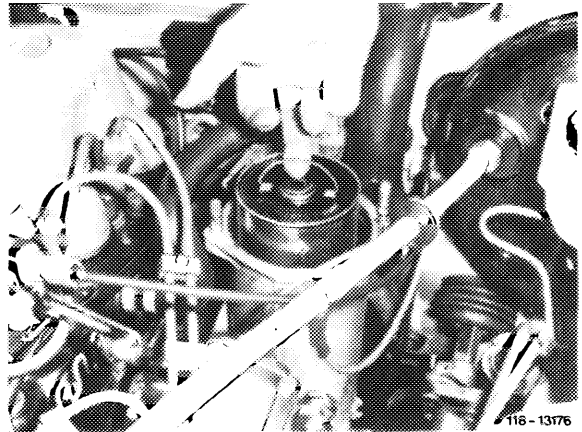

- Replace rubber sealing ring (1) on cover.
- Check sealing ring (2) on central screw and replace according to condition.

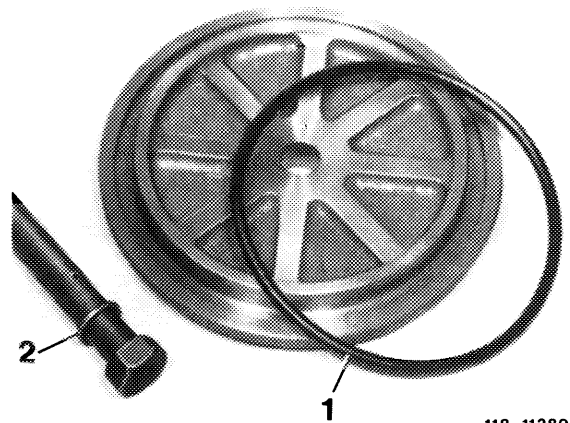

1st version

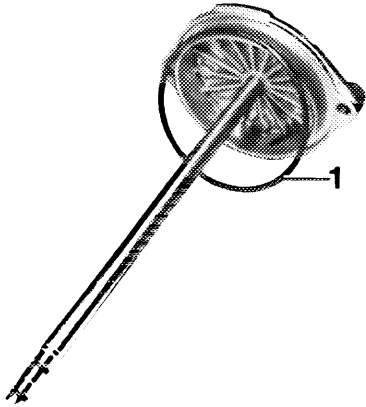

118 - 13177

- Renew rubber gasket on cover.

2nd version

- Tighten central screw or fastening nuts resp. with torque wrench to 20 – 25 Nm (2.0 – 2.5 kpm).

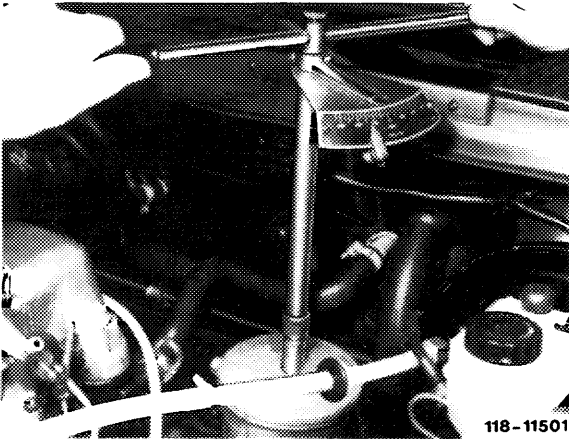

118 - 11501

1st version

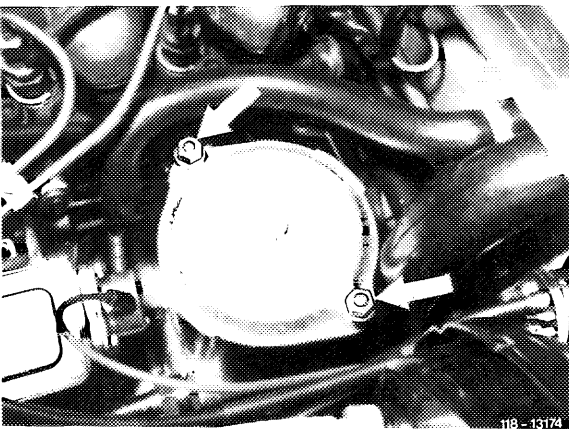

118 - 13174

2nd version

- If oil has been drained from oil pan, replace sealing ring on oil drain plug.

- Tighten drain plug to 40 Nm (4 kpm).

- Fill with engine oil.

- Run engine and check for leaks.

- Check oil level with the engine switched off.

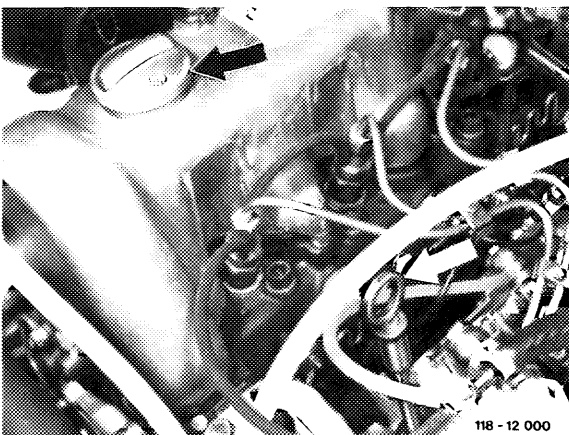

118 - 12 000

Engine oil and filter change

Revision: Note concerning filter elements added.

Engine 617.950
in model 116
Starting model year 1978

**Specified viscosity classes
acc. to SAE for continuous outside temperatures**

**Important! Do not use single-grade SAE 10 W oil
in this engine.**

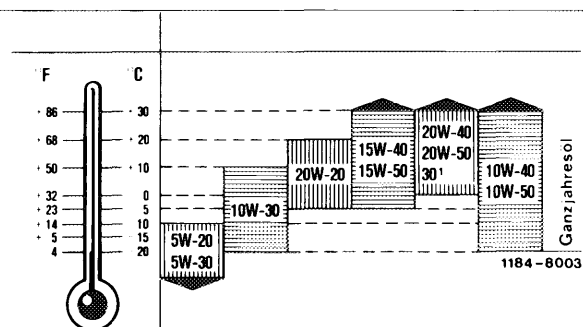

¹⁾ SAE 40 may be used if ambient temperatures constantly exceed +30°C (+86°F).

Oil capacity in liters (For approved engine oil types refer to „Specifications for Service Products“)

Oil capacity during oil and filter change	7.5
Oil pan	6.0

Oil dipstick color code **white**

Tightening torques	Nm	(kpm)
Central screw — oil filter cover	20–25	(2.0–2.5)
Oil drain plug — oil pan	40	(4)

Special tool

Torque wrench $\frac{3}{8}$ " square,
8–32 Nm (80–320 kpcm)

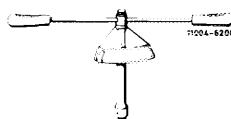

001 589 51 21 00

Note:

On this engine, only the filter element (B),
Part No. 617 184 01 25, must be used.

- A Filter element, Part No. 617 184 00 25
Dimension a = 40 mm (not for this engine)
- B Filter element, Part No. 617 184 01 25
Dimension B = 55 mm

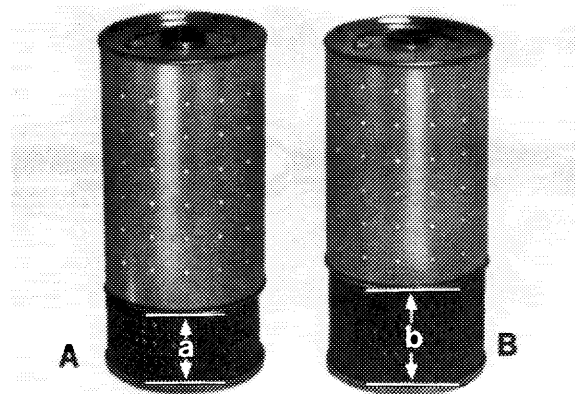

118-13935/2



Prior to extracting or draining the engine oil, drain oil filter. To do this, unscrew the nuts and remove the cover.

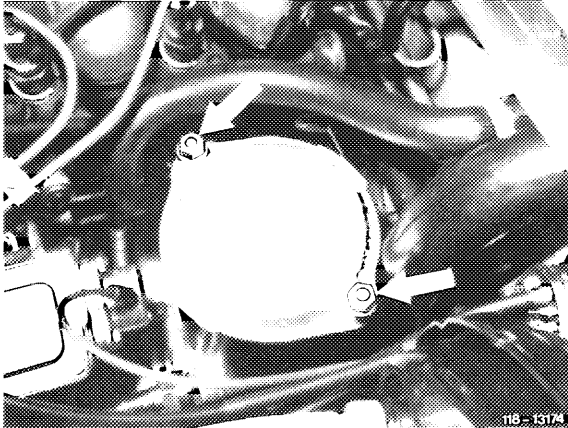

- Loosen both nuts and remove filter cover.

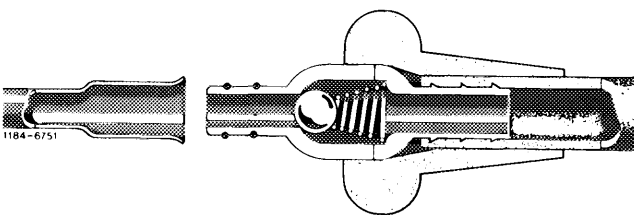
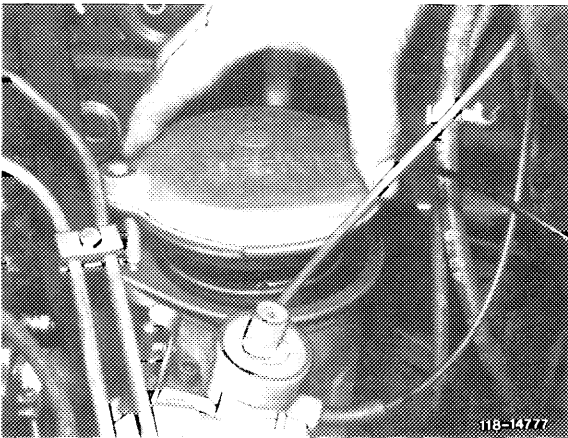

- Draw off engine oil with engine at operating temperature.

If no drawing off unit is available.

- Drain engine oil from oil pan.

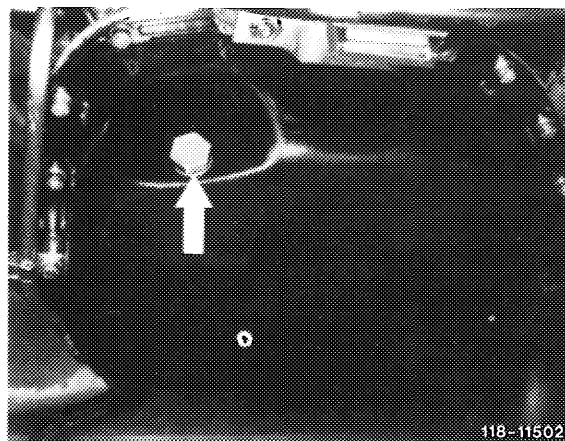

- Replace filter element.

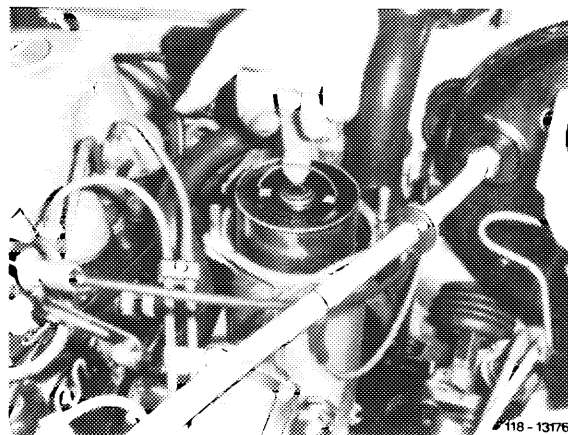

- Renew rubber gasket on cover.

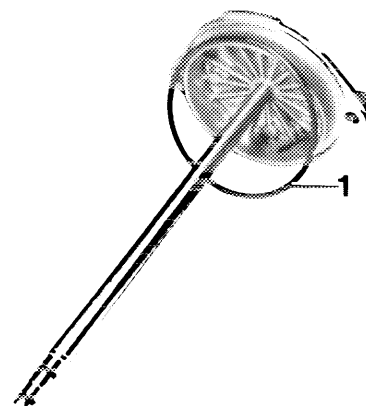

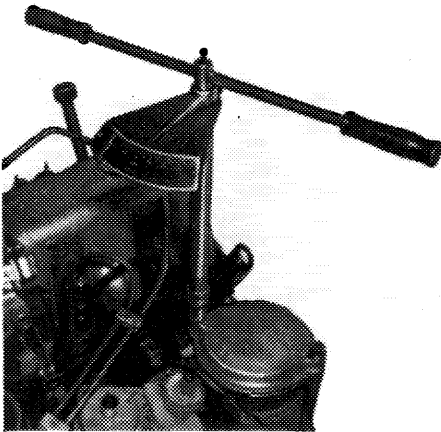

118-15962

- Tighten fastening nuts resp. with torque wrench to 20 – 25 Nm (2.0 – 2.5 kpm).

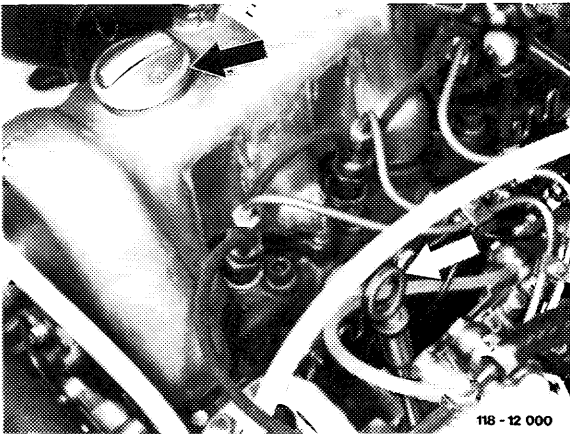

118-12 000

- If oil has been drained from oil pan, replace sealing ring on oil drain plug.
- Tighten drain plug to 40 Nm (4 kpm).
- Fill with engine oil.
- Run engine and check for leaks.
- Check oil level with the engine switched off.